

# IMA

## INTEGRATED MOTOR ROD-STYLE ACTUATOR

**ENDURANCE TECHNOLOGY**<sup>SM</sup>  
A Tolomatic Design Principle  
**Patented**



**LINEAR SOLUTIONS MADE EASY**

# The longest lasting, high-force integrated actuator on the market!

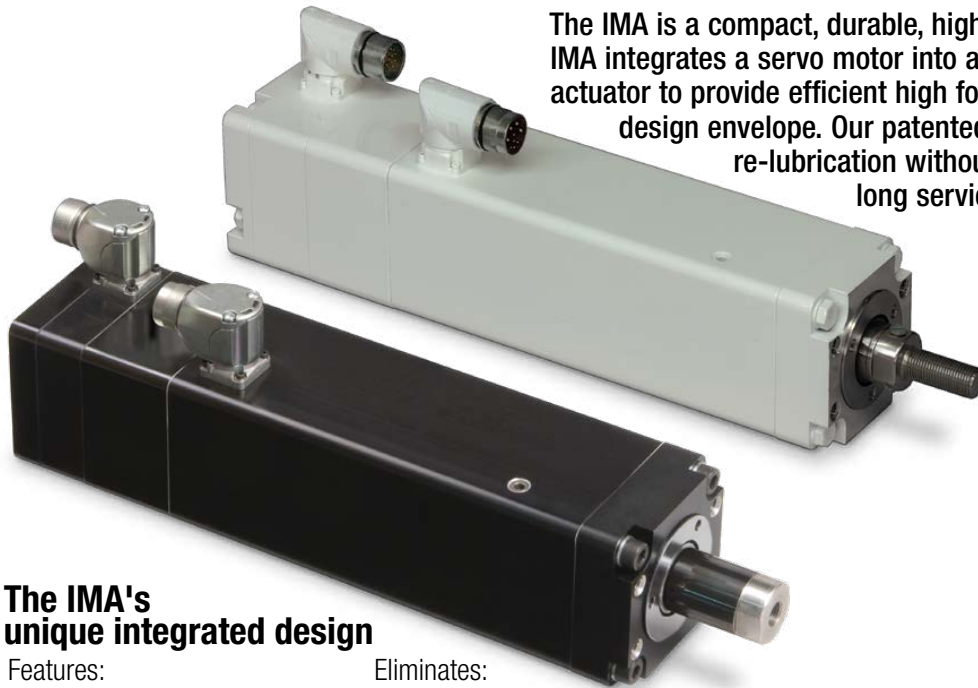

The IMA is a compact, durable, high force rod-style actuator. The IMA integrates a servo motor into a ball or roller screw-driven actuator to provide efficient high force in a compact lightweight design envelope. Our patented\* design allows for easy re-lubrication without disassembly for extremely long service life.

\*U.S. PATENT NO. 8,196,484

## The IMA's unique integrated design

Features:

- Compact, lightweight design
- Long life
- High force
- High positional accuracy
- High efficiency
- Proven performance
- Ratings for extreme environments
- Compatibility
- Low inertia





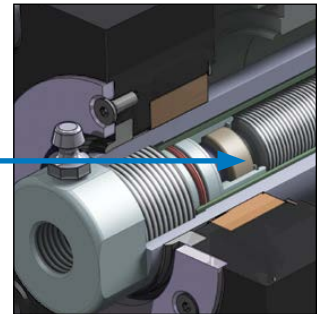

Eliminates:

- Couplers
- Adapters
- Belts
- Gears
- Unneeded assembly labor
- Forced air or water cooling
- Hydraulic systems
- Pneumatic systems
- Need for multiple vendors

**PATENTED  
SCREW  
LUBRICATION  
SYSTEM FOR  
EXTENDED  
SERVICE LIFE**



## TOLOMATIC'S ELECTRIC ROD-STYLE ACTUATORS

	ERD	RSH	RSA	GSA	RSX	IMA
						
	Rod-Style Actuator	Hygienic Rod-Style Actuator	Rod-Style Actuator	Guided Rod-Style Actuator	Rod-Style Actuator	Integrated Servo Actuator
<b>Force</b> up to:	500 lbf (2.2 kN)	7,900 lbf (35.3 kN)	13,000 lbf (58.0 kN)	950 lbf (4.2 kN)	50,000 lbf (222.4 kN)	6,900 lbf (30.6 kN)
<b>Speed</b> up to:	58 in/sec (1,473 mm/sec)	20 in/sec (500 mm/sec)	123 in/sec (3,124 mm/sec)	123 in/sec (3,124 mm/sec)	30 in/sec (760 mm/sec)	53 in/sec (1,334 mm/sec)
<b>Stroke Length</b> up to:	24 in (610 mm)	48 in (1,200 mm)	60 in (1,520 mm)	36 in (910 mm)	35 in (890 mm)	18 in (460 mm)
<b>Screw/Nut Type</b>	Solid & Ball	Ball & Roller	Solid, Ball & Roller	Solid & Ball	Roller	Ball & Roller
<i>For complete information see <a href="http://www.tolomatic.com">www.tolomatic.com</a> or literature number:</i>						
<b>Literature Number:</b>	2190-4000	2100-4010	3600-4166	3600-4166	2171-4001	2700-4000

(Not all models deliver maximum values listed, i.e.: Maximum thrust may not be available with maximum speed)

# IMA - Integrated Motor Actuator

## IMA Applications

**Press Fitting System**

- High Force
- Long Life



**Valve / Process Control**

- Efficient
- Accurate Positioning
- Quick Response

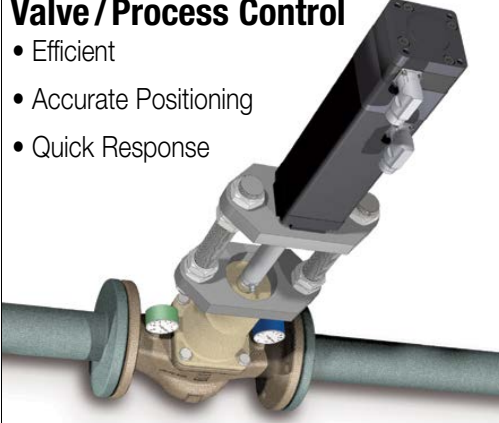

**CONTENTS**

- What is the IMA? . . . . . 2
- IMA Applications . . . . . 3
- IMA Features . . . . . 4
- IMA Specs & Performance . . . . . 8-14
- IMA Dimensions . . . . . 15-18
- Application Data Worksheet . . . . . 19
- Selection Guidelines . . . . . 20
- Ordering . . . . . 23

**Spot Welding**

- Compact, Lightweight
- Repeatable, High Force



**Fluid Dispensing**

- Repeatable Force
- Smooth Velocity

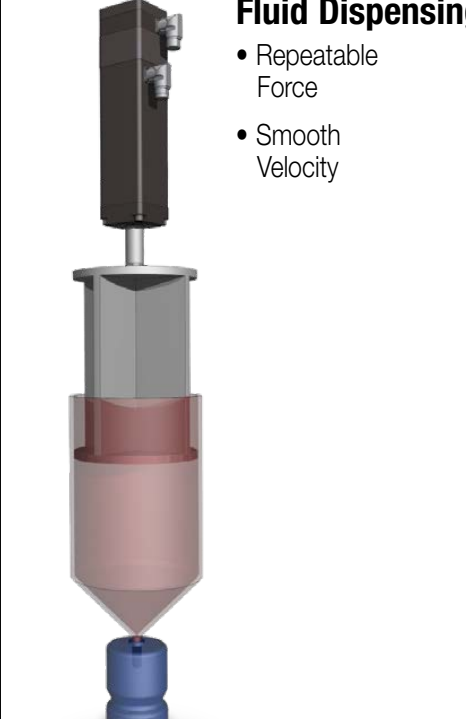

**More Applications:**

- Aerospace
- Animation
- Assembly
- Automated assembly
- Automatic tool changers
- Automotive
- Clamping
- Converting
- Conveyors
- Cycle testing
- Fillers
- Formers
- Hydraulic replacement
- Laser positioning
- Machine tools
- Material handling systems
- Medical equipment
- Military
- Molding
- Motion simulators
- Open / close doors
- Packaging equipment
- Parts clamping
- Patient lifts
- Pick & place
- Pneumatic replacement
- Precision grinders
- Product test simulations
- Riveting / fastening / joining
- Robot manipulator arms
- Sawmill equipment
- Semiconductor
- Stamping
- Table positioning
- Tension control
- Test stands
- Tube bending
- Volumetric pumps
- Water jet control
- Wave generation
- Web guidance
- Welding
- Wire winding

# IMA INTEGRATED MOTOR ACTUATOR

The IMA is a compact, durable, high force rod-style actuator with an IP65 rating. The IMA integrates a servo motor into a ball or roller screw-driven actuator to provide efficient high force in a compact lightweight design envelope. Our patented design allows for easy re-lubrication without disassembly for extremely long service life. Built-to-order in stroke lengths up to 450 mm (18") with your choice of screw technology.

## ENDURANCE TECHNOLOGY<sup>SM</sup>

A Tolomatic Design Principle

### HIGH POSITIONAL ACCURACY

#### SCREW ACCURACY

Roller Nut	$\pm 0.0004"/ft.$	$\pm 0.0102mm/300mm$
Ball Nut	$\pm 0.002"/ft.$	$\pm 0.051mm/300mm$

### REPLACEABLE ROD WIPER

- Prevents contaminants from entering the actuator for extended life

### GREASE PORT

- Screw re-lubrication system provides extended screw service life
- Convenient lubrication without disassembly (IMA22 is lubed for life and does not include grease port)

### INTEGRAL MOUNTING

- Four metric threaded holes on front face are available for direct mounting or addition of customized options

### THREADED ROD END

- Zinc plated alloy steel construction for corrosion resistance
- Provides a common interface to multiple rod end options

### THRUST TUBE

- Steel thrust tube supports extremely high force capabilities
- Salt bath nitride treatment provides excellent corrosion resistance, surface hardness and is very resistant to adherence of weld slag, water and other potential contaminant

### MULTIPLE SCREW TECHNOLOGIES

#### YOU CAN CHOOSE:

- Ball screws offer efficiency at a cost effective price
- Roller screws provide the highest force and life ratings available



### INTERNAL BUMPERS

- Bumpers protect the screw and nut assembly from damage at end of stroke

### LIGHTWEIGHT ALUMINUM DESIGN

- Black anodized extrusion design is optimized for rigidity and strength

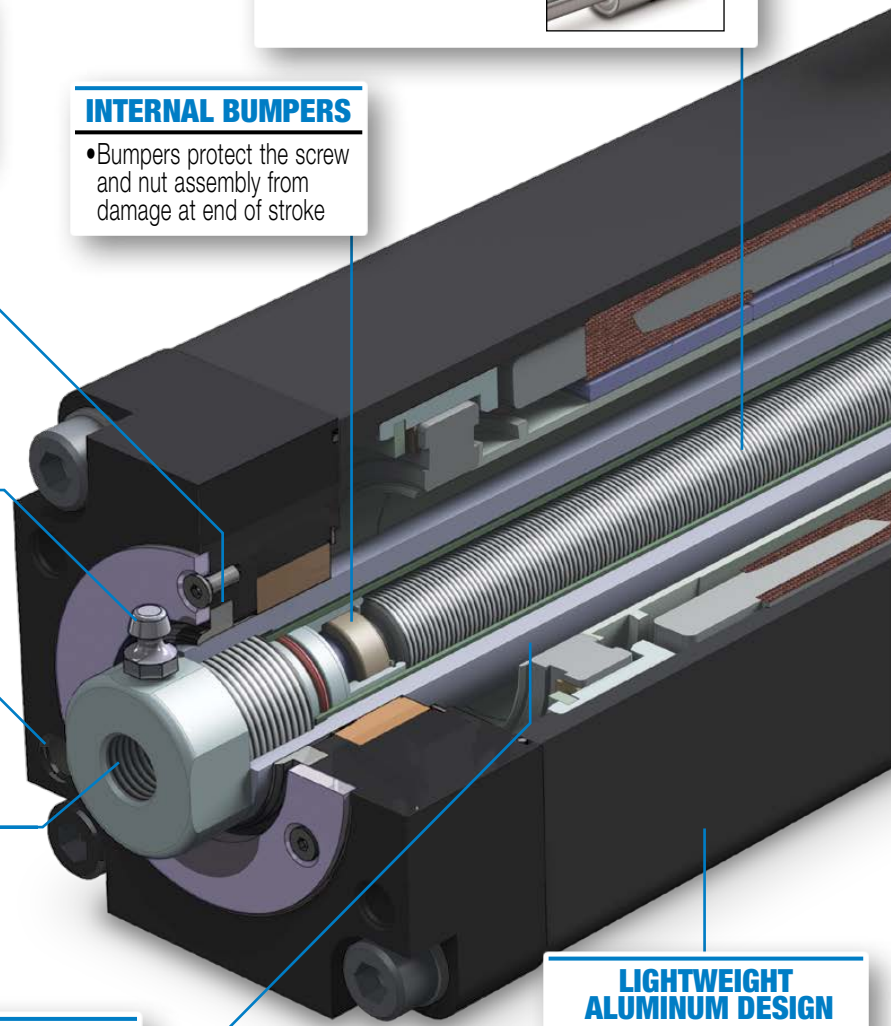



# Tolomatic... MAXIMUM DURABILITY

EXCELLENCE IN MOTION

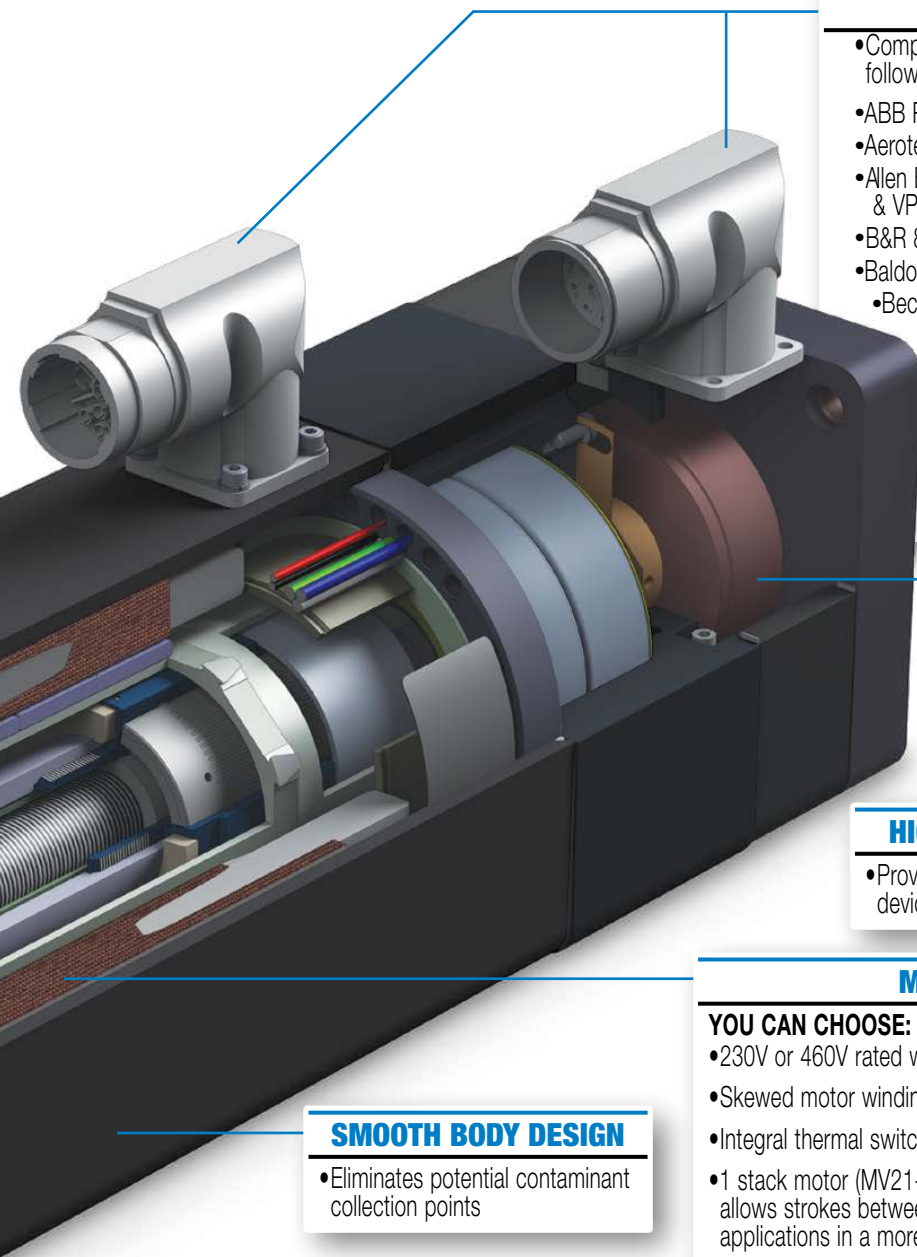

## ROBOT & DRIVE/CONTROLLER COMPATIBILITY

- Compatible feedback, connector(s) and wiring to match the following robot & drive/controller manufacturers:
  - ABB Robot\*
  - Aerotech BM\*
  - Allen Bradley MP & VP
  - B&R 8LS\*
  - Baldor BSM
  - Beckhoff AM8\*
  - Bosch Rexroth MSK
  - Nidec/Control Techniques FM & NT
  - Fanuc Robot\*
  - Kawasaki Robot\*
  - Kollmorgen AKM\*
  - Kuka Robot\*
  - Lenze MCA
  - Motoman / Yaskawa Robot\*
  - Nachi Robot\*
  - Omron\*
  - Parker MPP\*
  - Schneider Electric SH\*
  - SEW CMP\*
  - Siemens 1F\*
  - Stober\*
- \*Consult Tolomatic for lead time
- Tolomatic standard connector, wiring and flying lead cable can be used to integrate with servo drive manufacturers such as:
  - AMC
  - Copley
  - Elmo
  - + Others
- STAGGERED CONNECTORS for convenient installation

## HIGH RESOLUTION FEEDBACK

### YOU CAN CHOOSE:

- Incremental encoder
- Multi-turn absolute encoder, Hiperface, Hiperface DSL, EnDat 2.2
- Resolver

## HIGH FORCE ANGULAR CONTACT BEARINGS

- Provides complete support of screw and protects the feedback device from linear forces

## MULTIPLE MOTOR WINDINGS

### YOU CAN CHOOSE:

- 230V or 460V rated windings potted directly into actuator housing
- Skewed motor windings provide minimal torque ripple for smooth linear motion
- Integral thermal switch for over temperature protection
- 1 stack motor (MV21-230V & MV41-460V) available for the IMA22 & IMA33, allows strokes between 3 and 6" providing the force needed for many applications in a more compact, lighter weight packages

## SMOOTH BODY DESIGN

- Eliminates potential contaminant collection points



### Modifications:

- Contact Tolomatic for stainless steel, manual override or food grade versions of the IMA (See the white paint IMA on the next page)

## OPTIONS

### MOUNTING

- Front Face - Standard
- Side Mounting Holes, 2 sides & bottom (no photo)
- Mounting Plates
- Rear Clevis
- Front Flange
- Trunnion, Rear or Front

### ROD END

- Internal Thread - Standard
- External Threads
- Clevis
- Spherical Eye
- Alignment Coupler

### BRAKE

- 24V Spring held / electronically released

- IP67 • For protection against water and dust ingress

### CABLES

- Signal Cable (5 & 10 m)
- Power Cable (5 & 10 m)

- ARO • Anti-Rotate

# FOOD GRADE IMA

The food grade IMA has all the features of the IMA shown on the previous pages plus features that are suited to challenging environments: Stainless steel rod, rod end, fasteners; food grade white paint; IP67 rating; Viton seals and food grade grease. The white paint IMA is a great option for the food & beverage processing environment. Contact Tolomatic for lead time

## ENDURANCE TECHNOLOGY<sup>SM</sup>

A Tolomatic Design Principle

### GREASE PORT

- Pictured with plug, grease zerk also available. Both made with corrosion resistant 316 stainless steel. Replace plug with zerk to lubricate
- Screw relubrication system provides extended screw service life
- Convenient lubrication without disassembly (IMA22 is lubed for life and does not include grease port)

### FOOD GRADE PAINT

- FDA & USDA approved
- White paint reveals any foreign matter to ease clean-up.

### SMOOTH BODY DESIGN

- Fewer collection points for contaminants in wash-down environments

### VITON® SEALS

- Viton®, a high performance elastomer, has a proven reputation for outstanding performance in hot and corrosive environments.

### 300 SERIES STAINLESS STEEL FASTENERS

- For corrosion resistance even if white epoxy is removed
- Hex bolts for fewer collection points for contaminants in wash-down environments

### 300 SERIES STAINLESS STEEL ROD

- Corrosion resistant 316 stainless steel thrust rod

### FIELD SERVICEABLE VITON® WIPER

- State-of-the-art wiper prevents contaminants from entering the actuator for extended life

### IP67 RATED

- Static tested against ingress of dust and water for protection of internal components and long actuator life

**IP67:** Ingress Protection: **First Digit** = Solids, 6 = Dust Tight (No ingress of dust; complete protection against contact)  
**Second Digit** = Liquids, 7 = Immersion up to 1 m (Ingress of water in harmful quantity shall not be possible when the enclosure is immersed in water under defined conditions of pressure and time up to 1 m of submersion)

### OPTIONS MOUNTING

- Front Face - Standard
- Side Mounting Holes, 2 sides & bottom (no photo)
- Rear Clevis
- Front Flange
- Trunnion, Rear or Front

**Tolomatic**... MAXIMUM DURABILITY  
 EXCELLENCE IN MOTION

# IMA-S STAINLESS STEEL ACTUATOR

The IMA-S is a hygienically designed integrated servo actuator for the food and beverage processing industry. The IMA-SA option incorporates an internal anti-rotate feature. Clean-in-place compatibility and the hygienic features of the IMA-S make it the perfect actuator for applications such as volumetric filling and pumping.

## ENDURANCE TECHNOLOGY<sup>SM</sup>

A Tolomatic Design Principle

See IMAS brochure  
(English 2700-4014) for  
complete information.

### EFFICIENT INTEGRATED MOTOR DESIGN

- Skewed winding minimizes cogging torque for smooth, repeatable motion
- Low electric time constant motor for quick response
- Power dense

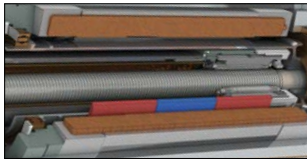

### STAINLESS STEEL DESIGN

- 316 Stainless steel construction
- Superior corrosion resistance

### GREASE PORT

- Integrated into rod end for hygienic design
- Screw re-lubrication system via needle zerk extends screw service life

### WELDED JOINTS

Welded, polished joints create the most hygienic seam

### BLUE GASKETS & O-RINGS

- Chemically inert
- Wear resistant
- FDA approved

### FLEXIBLE FEEDBACK & CABLE OPTIONS



Single (DSL) and dual cable options

### FIELD REPLACEABLE SEAL CARTRIDGE

- IP69K rated, wash-down protection
- Clean-in-place compatible
- FDA approved seal cartridge option

### MULTIPLE SCREW TECHNOLOGIES

- Ball screws provide efficient motion at an economical price



- Roller screws provide the highest force and longest life



### ADDITIONAL OPTIONS

- Brake
- Externally threaded rod end
- Front flange mount
- Rear clevis mount
- Hygienic fasteners
- FDA approved seal cartridge

**Tolomatic**<sup>TM</sup>... MAXIMUM DURABILITY  
EXCELLENCE IN MOTION





## Performance & Mechanical Specifications:

SERIES	STACK <sup>1</sup>	NUT/ SCREW	SCREW LEAD	DYNAMIC LOAD RATING (1 MIL. REV/S)	CONT. THRUST	PEAK THRUST	MAX. VELOCITY	BASE INERTIA <sup>2</sup>	INERTIA PER UNIT OF STROKE	BREAK- AWAY TORQUE	NOMINAL BACK DRIVE FORCE <sup>3</sup>
			mm	kN	kN	kN	mm/sec	kg-cm <sup>2</sup>	kg-cm <sup>2</sup> / mm	N-m	N
IMA22	1	BN05	5	5.72	0.89	1.45	356	0.9007	0.00014	0.34	218
	3	BN05	5	5.72	1.45	1.45	356	1.4859	0.00014	0.34	218
	1	BN10	10	4.40	0.45	1.36	711	0.9007	0.00019	0.34	109
	3	BN10	10	4.40	0.80	1.45	711	1.4859	0.00019	0.34	109
IMA33	1	BN05	5	8.71	1.62	4.45	305	2.7696	0.00031	0.54	347
	3	BN05	5	8.71	4.00	4.45	292	4.8709	0.00031	0.54	347
	1	BN10	10	5.40	0.81	2.44	610	2.7908	0.00036	0.54	173
	3	BN10	10	5.40	2.00	4.00	584	4.8922	0.00036	0.54	173
	1	BN20	20	11.39	0.41	1.23	1,219	3.0003	0.0014	0.54	89
	3	BN20	20	11.39	1.00	3.00	1,168	5.2184	0.0014	0.54	89
	1	RN04	4	41.10	2.0	6.0	244	2.7835	0.00036	0.60	434
	3	RN04	4	41.10	4.7	11.1	234	4.8847	0.00036	0.60	434
	1	RN05	5	45.42	1.6	4.7	305	2.7874	0.00041	0.60	347
	3	RN05	5	45.42	3.8	11.1	292	4.8937	0.00041	0.60	347
	1	RN10	10	45.42	0.8	2.3	610	2.8145	0.00048	0.60	173
	3	RN10	10	45.42	1.9	5.7	584	4.9208	0.00048	0.60	173
IMA44	3	BN05	5	17.95	7.78	8.90	292	10.0063	0.00209	0.63	405
	3	BN10	10	15.00	3.89	7.78	584	10.0459	0.00216	0.63	205
	3	BN25	25	11.29	1.56	3.11	1,334	10.3231	0.00265	0.63	80
	3	RN04	4	56.51	9.3	17.8	234	9.7764	0.00105	0.70	507
	3	RN05	5	56.51	7.3	14.7	292	9.7864	0.00113	0.70	405
	3	RN10	10	56.51	3.7	11.1	584	9.8334	0.00122	0.70	205
IMA55	3	BN05	5	29.87	13.13	13.35	201	77.9185	0.01757	1.06	681
	3	BN10	10	33.26	6.56	13.13	399	78.0428	0.01773	1.06	343
	3	BN20	20	24.59	3.28	8.21	797	78.5208	0.01836	1.06	169
	3	RN05	5	106.06	12.2	30.6	201	76.6569	0.01273	1.16	676
	3	RN10	10	106.06	6.1	15.3	399	76.7962	0.01291	1.16	338

			in	lbf	lbf	lbf	in/sec	lb-in <sup>2</sup>	lb-in <sup>2</sup> / in	in-lb	lbf
IMA22	1	BN05	0.197	1,286	200	325	14.0	0.3078	0.00123	3.0	49
	3	BN05	0.197	1,286	325	325	14.0	0.5078	0.00123	3.0	49
	1	BN10	0.394	989	102	305	28.0	0.3078	0.00161	3.0	25
	3	BN10	0.394	989	180	325	28.0	0.5078	0.00161	3.0	25
IMA33	1	BN05	0.197	1,958	365	1,000	12.0	0.9464	0.00266	4.8	78
	3	BN05	0.197	1,958	900	1,000	11.5	1.6645	0.00266	4.8	78
	1	BN10	0.394	1,214	183	549	24.0	0.9537	0.00313	4.8	39
	3	BN10	0.394	1,214	450	900	23.0	1.6717	0.00313	4.8	39
	1	BN20	0.788	2,560	92	276	48.0	1.0253	0.01211	4.8	20
	3	BN20	0.788	2,560	225	675	46.0	1.7832	0.01211	4.8	20
	1	RN04	0.157	9,236	450	1,350	9.6	0.9513	0.00314	5.3	98
	3	RN04	0.157	9,236	1,063	2,500	9.2	1.6694	0.00314	5.3	98
	1	RN05	0.197	10,211	350	1,050	12.0	0.9525	0.00358	5.3	78
	3	RN05	0.197	10,211	850	2,500	11.5	1.6723	0.00358	5.3	78
	1	RN10	0.394	10,211	175	525	24.0	0.9618	0.00413	5.3	39
	3	RN10	0.394	10,211	425	1,275	23.0	1.6815	0.00413	5.3	39
IMA44	3	BN05	0.197	4,035	1,750	2,000	11.5	3.4193	0.01811	5.6	91
	3	BN10	0.394	3,372	875	1,750	23.0	3.4329	0.01872	5.6	46
	3	BN25	0.985	2,537	350	700	52.5	3.5276	0.02303	5.6	18
	3	RN04	0.157	12,703	2,100	4,000	9.2	3.3412	0.00917	6.2	114
	3	RN05	0.197	12,703	1,650	3,300	11.5	3.3442	0.00984	6.2	91
	3	RN10	0.394	12,703	825	2,500	23.0	3.3602	0.01056	6.2	46
IMA55	3	BN05	0.197	6,714	2,950	3,000	7.9	26.626	0.15246	9.4	153
	3	BN10	0.394	7,476	1,475	2,950	15.7	26.6684	0.15385	9.4	77
	3	BN20	0.788	5,528	738	1,845	31.4	26.8318	0.15939	9.4	38
	3	RN05	0.197	23,843	2,750	6,875	7.9	26.1949	0.11051	10.3	152
	3	RN10	0.394	23,843	1,375	3,440	15.7	26.2425	0.11204	10.3	76

Performance data was validated using an aluminum face mount plate:  
 IMA22 (8.25" x 7.0" x 0.7");  
 IMA33 (8.25" x 7.0" x 0.7");  
 IMA44 (9.0" x 9.0" x 0.7");  
 IMA55 (9.0" x 9.0" x 1.0")  
 Ambient Temp. = 77°F (25°C);  
 Elevation < 3281' (1,000 m);  
 Drive specifications: Sinusoidal Commutation and PWM Voltage Source

<sup>1</sup> Stack winding MV21 / 41  
 3 Stack winding MV23 / 43

<sup>2</sup>Value given is for a zero stroke actuator † To be determined, visit [www.tolomatic.com](http://www.tolomatic.com) for up-to-date information

<sup>3</sup>In all vertical application an unpowered IMA will require a brake to maintain position. Tolomatic recommends that the nominal back drive force specification be used for reference only. Back drive force is subject to change throughout the life of the actuator, due to mechanical break in, ambient temperature, and duty cycle variation.

### Reference Only

Back drive force is subject to change throughout the life of the actuator, due to mechanical break in, ambient temperature, and duty cycle variation.





## Performance & Mechanical Specifications:

		IMA22 (1 STACK, MV21/41)	IMA22 (3 STACK, MV23/43)	IMA33 (1 STACK, MV21/41)	IMA33 (3 STACK, MV23/43)	IMA44	IMA55
FACE SIZE	mm	63.5	63.5	83	83	110	142
	in	2.5	2.5	3.3	3.3	4.4	5.6
STROKE	mm	76.2 to 304.8	152.4 to 304.8	76.2 to 457.2	152.4 to 457.2	152.4 to 457.2	152.4 to 457.2
	in	3.0 to 12.0	6.0 to 12.0	3.0 to 18.0	6.0 to 18.0	6.0 to 18.0	6.0 to 18.0
**BASE WEIGHT	kg	2.4	2.9	5.2	6.4	13	24.8
	lb	5.3	6.4	11.4	14.1	28.6	54.5
WEIGHT PER UNIT OF STROKE	kg/mm	0.0073	0.0073	0.0118	0.0118	0.0197	0.03771
	lb/in	0.2428	0.2428	0.6603	0.6603	1.1035	2.1115
SCREW LEAD ACCURACY	BN	in/ft = 0.002 mm/300 = 0.051 (0.004 in/ft for IMA33BN20 and IMA44BN25)					
	RN	in/ft = 0.0004 mm/300 = 0.010					
SCREW LEAD BACKLASH	BN	in = 0.004 mm = 0.1					
	RN	in = 0.0020 mm = 0.051					
TEMP RANGE	°C	Standard: 10 to 40; Extended: -20 to 60 (Contact Tolomatic if operation in the Extended Range is required)					
	°F	Standard: 50 to 104; Extended: -4 to 140 (Contact Tolomatic if operation in the Extended Range is required)					
IP RATING	Standard IP65, Optional IP67 (Static)						
REL. HUMIDITY (NON-CONDENSING)	5 to 90%						
SHOCK	20g peak, 6 msec duration						
VIBRATION	2.5g 30....2,000 Hz						

\*In vertical applications an unpowered IMA will require a brake to maintain position if the load on the actuator exceeds this value

\*\*Value given is for a zero stroke actuator

## Motor Specifications:

		IMA22				IMA33				IMA44		IMA55	
WINDING/MOTOR VOLTAGE		MV21	MV41	MV23	MV43	MV21	MV41	MV23	MV43	MV23	MV43	MV23	MV43
TORQUE CONSTANT (Kt)	N-m/A Peak	0.37	0.74	0.49	0.93	0.61	1.21	0.62	1.21	0.61	1.20	0.76	1.51
	in-lb/A Peak	3.3	6.6	4.3	8.2	5.4	10.7	5.5	10.7	5.4	10.6	6.7	13.4
VOLTAGE CONSTANT (Ke)	V/Krpm Peak	51	102	61	122	81	160	79.8	154	78.1	153.1	100	201
CONTINUOUS STALL TORQUE	N-m	0.85	0.85	1.50	1.50	1.8	1.8	4.4	4.3	8.4	8.5	12.7	12.7
	in-lb	7.5	7.5	13.3	13.3	16	16	39	38	74	75	112	112
CONTINUOUS STALL CURRENT	A <sub>RMS</sub>	1.6	0.8	2.2	1.15	2.1	1.1	5	2.5	9.7	5	11.8	5.9
PEAK TORQUE	N-m	2.54	2.54	4.5	4.5	5.4	5.4	13.2	12.9	25.1	25.4	31.6	31.6
	in-lb	22.5	22.5	39.9	39.9	48	48	117	114	222	225	280	280
PEAK CURRENT	A <sub>RMS</sub>	4.8	2.4	6.6	3.45	6.3	3.3	15	7.5	29.1	15	29.5	14.8
RESISTANCE	Ohms	18.1	72.4	7.1	28.3	10	40.1	2.07	8.3	0.58	2.32	0.57	2.93
INDUCTANCE	mH	10.7	42	4.5	18	13.6	54.1	3.8	15	2.75	11.5	1.4	5.8
BUS VOLTAGE	V <sub>RMS</sub>	230	460	230	460	230	460	230	460	230	460	230	460
SPEED @ RATED V	RPM	4,264				3,650		3,500		3,500		2,400	
NO. OF POLES		8											

RoHS Compliant Components;



Performance data was validated using an aluminum face mount plate: IMA22/33 (8.25" x 7.0" x 0.7"); IMA44 (9.0" x 9.0" x 0.7"); IMA55 (9.0" x 9.0" x 1.0"); Ambient Temperature = 77°F (25°C); Elevation < 3281' (1,000 m); Drive specifications: Sinusoidal Commutation and PWM Voltage Source



## SPEED vs THRUST

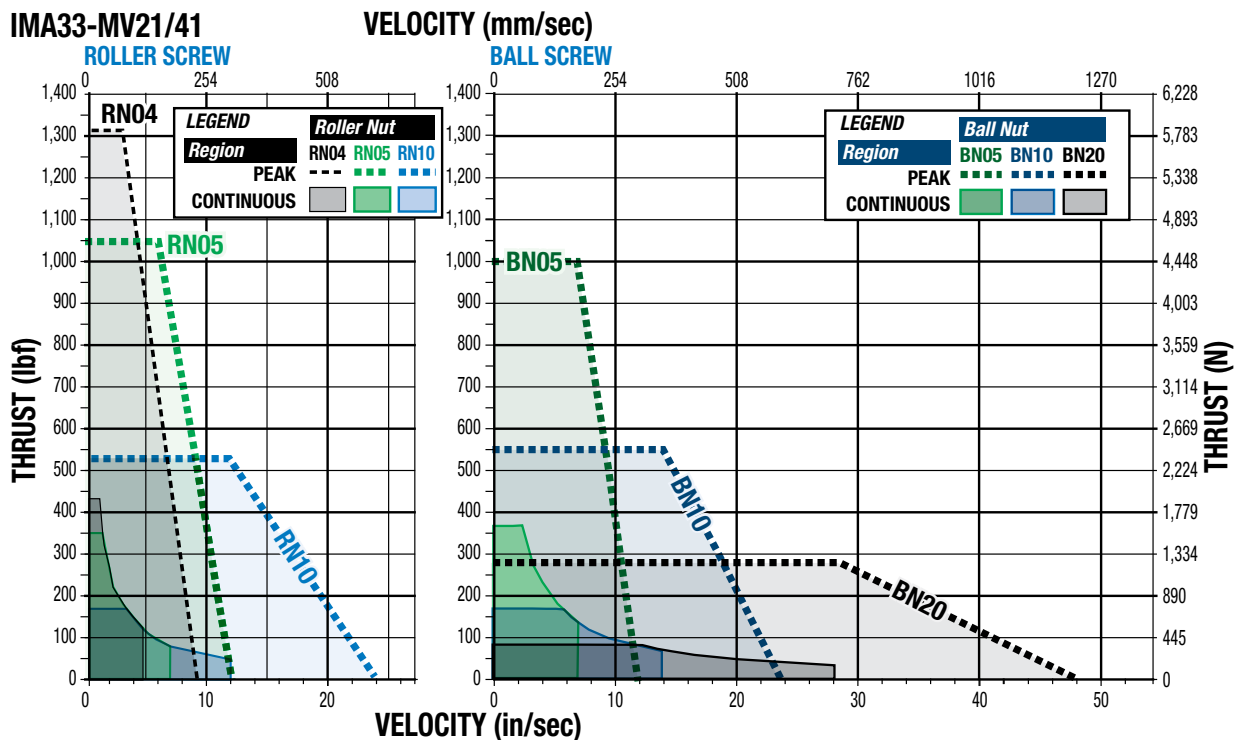
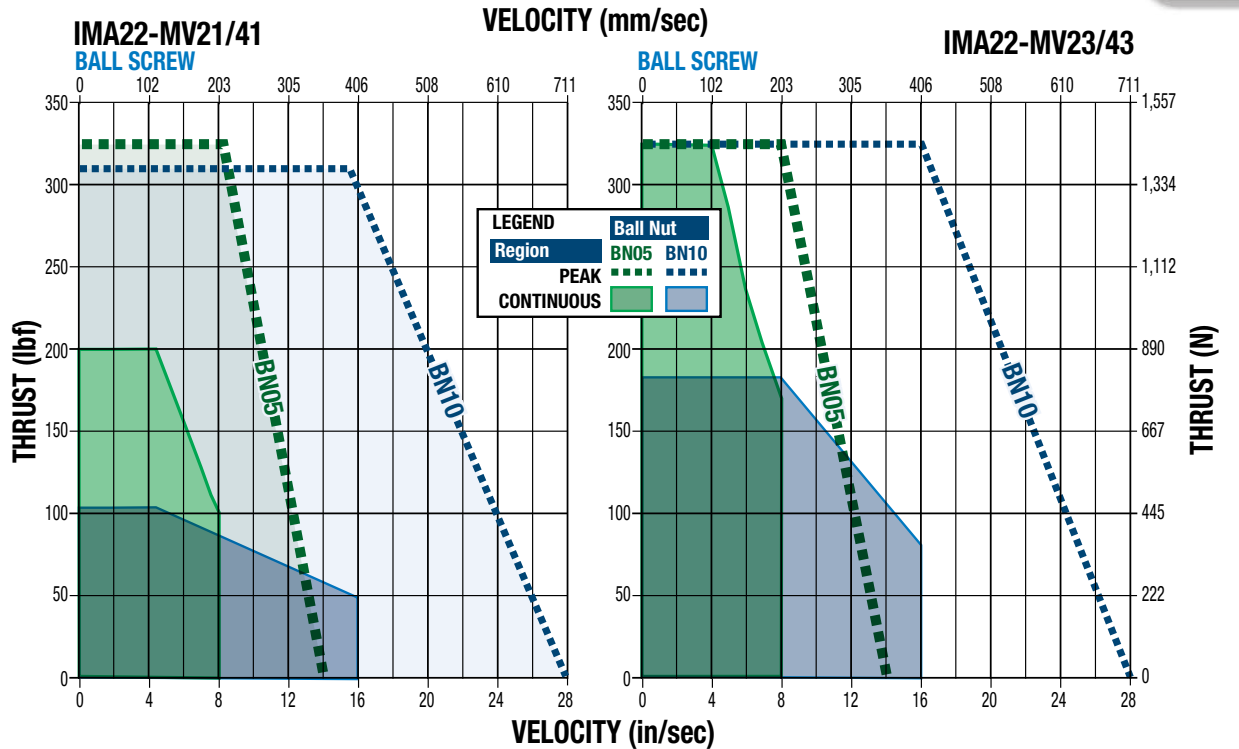

PEAK REGION is the maximum performance capabilities of the actuator system. Higher peak thrusts are achievable by servo motor actuator systems, so please consult Tolomatic before exceeding catalog rating.

CONTINUOUS REGION is defined as the RMS thrust and velocity limit that is derived from the thermal limits of the actuator system to achieve the dynamic load rating of the screw. (Example: Extend and retract under force 100% of the time with no dwells.)



## SPEED vs THRUST

IMA33-MV23/43

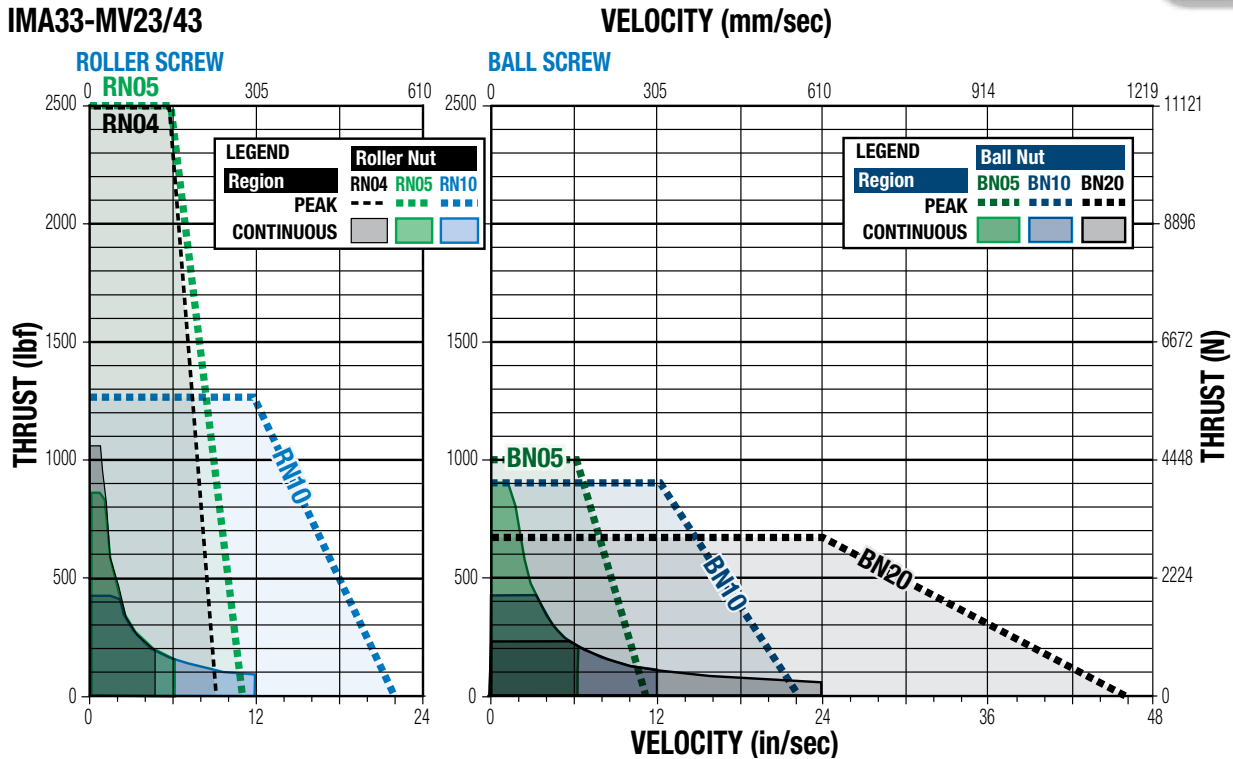

IMA44-MV23/43

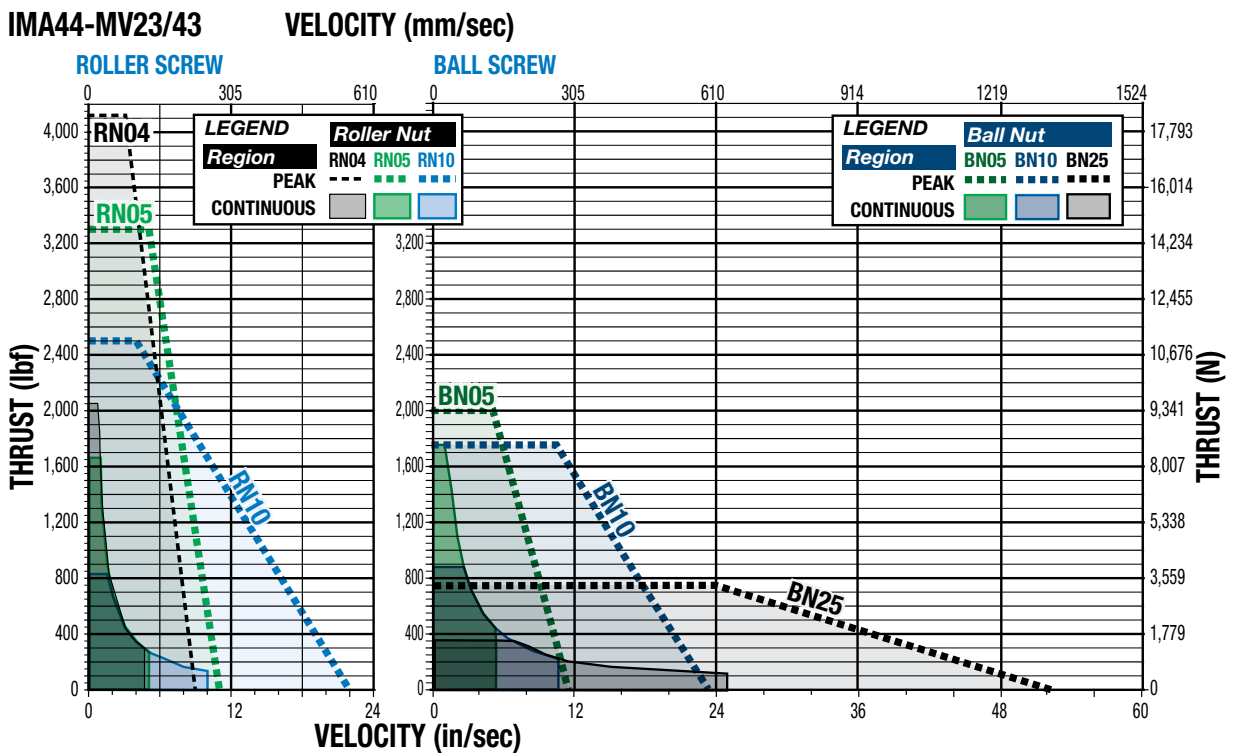

PEAK REGION is the maximum performance capabilities of the actuator system. Higher peak thrusts are achievable by servo motor actuator systems, so please consult Tolomatic before exceeding catalog rating.

CONTINUOUS REGION is defined as the RMS thrust and velocity limit that is derived from the thermal limits of the actuator system to achieve the dynamic load rating of the screw. (Example: Extend and retract under force 100% of the time with no dwells.)



## SPEED vs THRUST

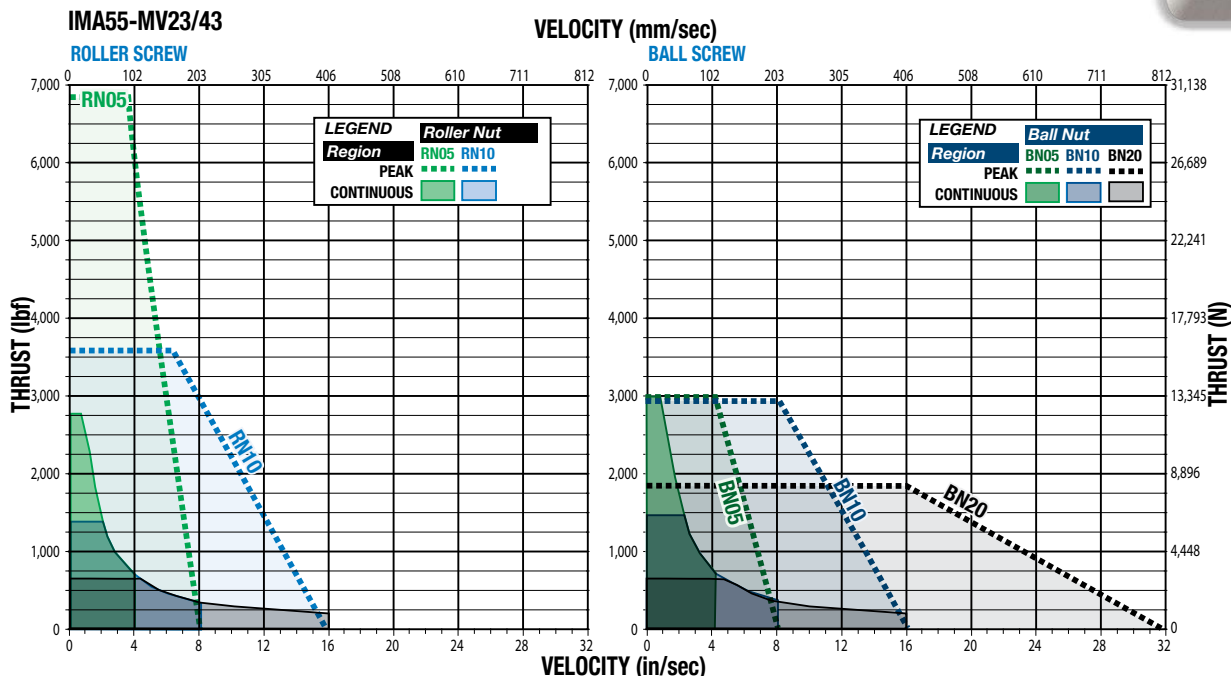

PEAK REGION is the maximum performance capabilities of the actuator system. Higher peak thrusts are achievable by servo motor actuator systems, so please consult Tolomatic before exceeding catalog rating.

CONTINUOUS REGION is defined as the RMS thrust and velocity limit that is derived from the thermal limits of the actuator system to achieve the dynamic load rating of the screw. (Example: Extend and retract under force 100% of the time with no dwells.)

## CRITICAL SPEED

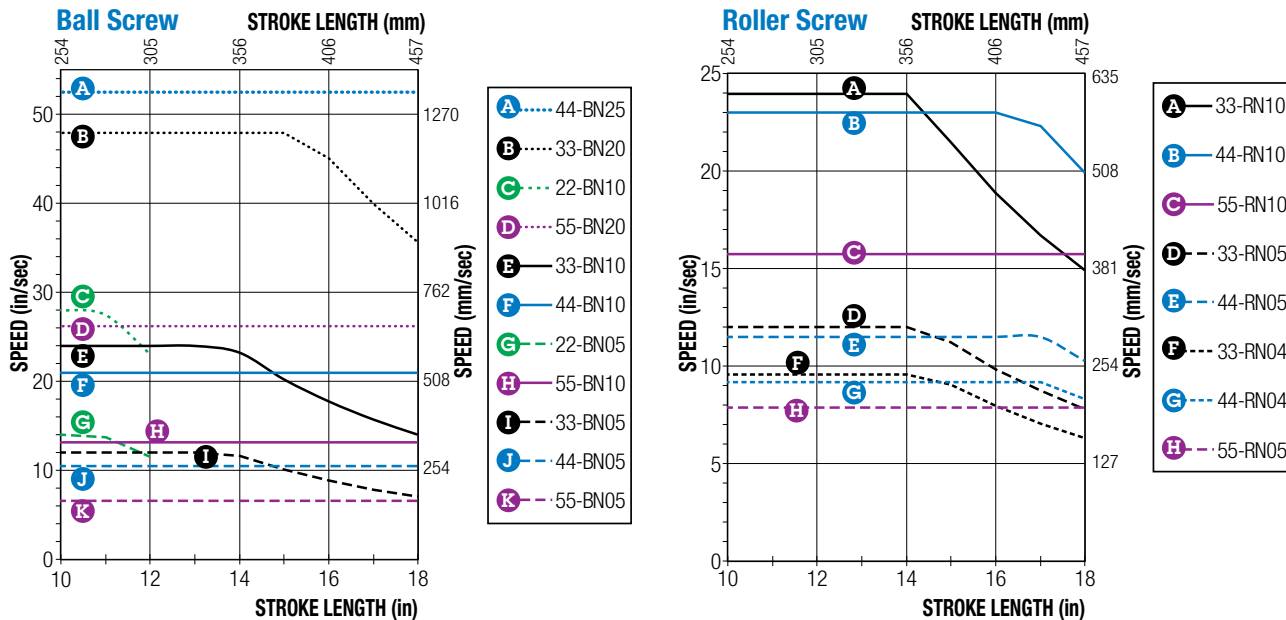

All curves represent properly lubricated and maintained actuators.





## SCREW BUCKLING LOAD

### BALL SCREW

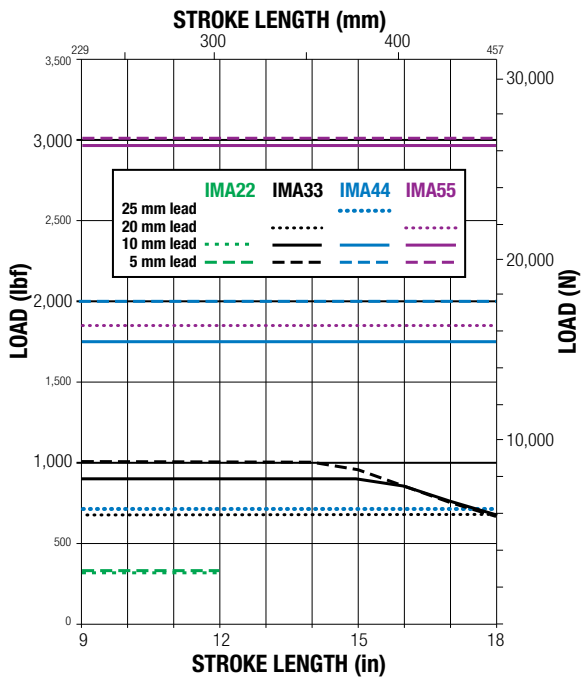

### ROLLER SCREW

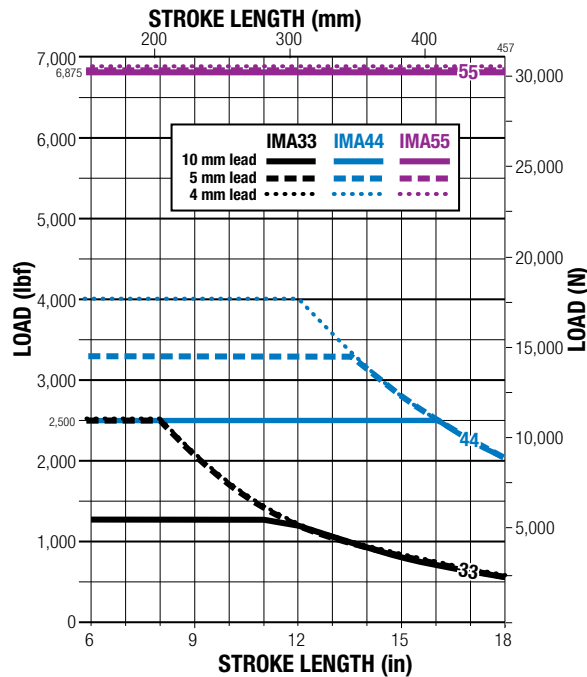

## LIFE

All curves represent properly lubricated and maintained actuators.

### BALL SCREW

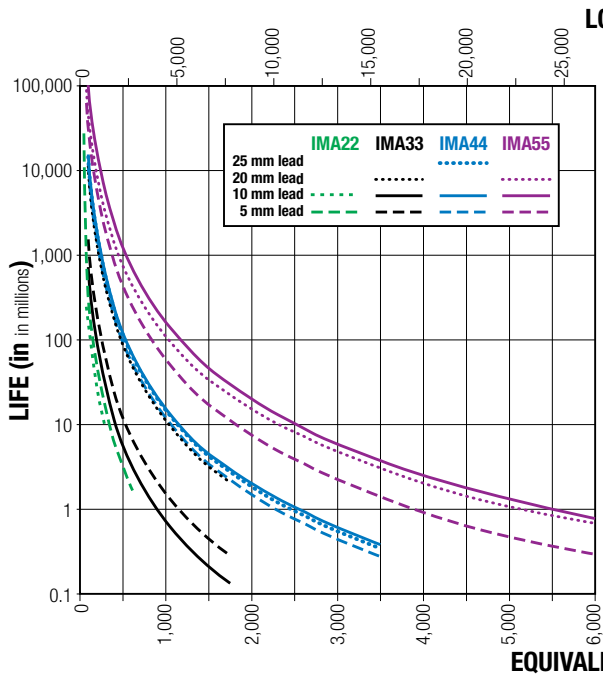

### ROLLER SCREW

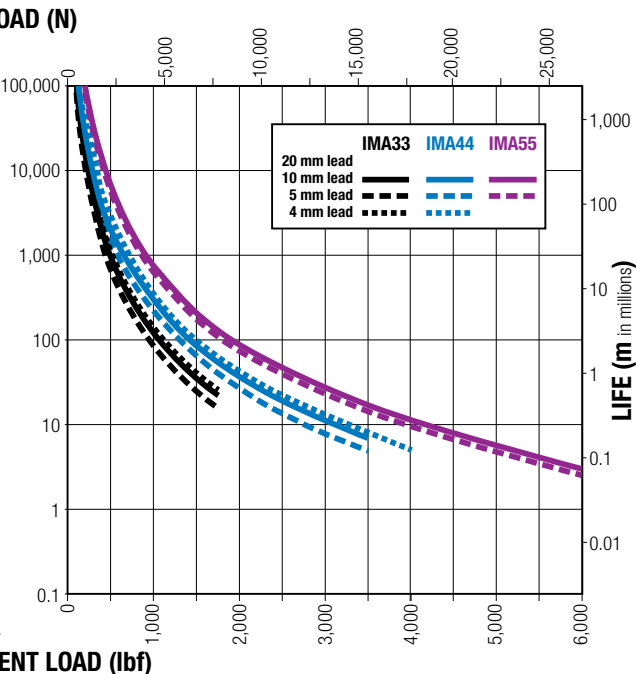

NOTE: The  $L_{10}$  expected life of a ball screw linear actuator is expressed as the linear travel distance that 90% of properly maintained ball screw manufactured are expected to meet or exceed. This is not a guarantee and this graph should be used for estimation purposes only.

The underlying formula that defines this value is:

$$L_{10} = \left( \frac{C}{P_e} \right)^3 \cdot \ell =$$

$L_{10}$  Travel life in millions of units (in or mm), where:

- C** = Dynamic load rating (lbf) or (N)
- $P_e$**  = Equivalent load (lbf) or (N)  
If load is constant across all movements then:  
actual load = equivalent load
- $\ell$  = Screw lead (in/rev) (mm/rev)

Use the "Equivalent Load" calculation below, when the load is not constant throughout the entire stroke. In cases where there is only minor variation in loading, use greatest load for life calculations.

Where:

$$P_e = \sqrt[3]{\frac{L_1(P_1)^3 + L_2(P_2)^3 + L_3(P_3)^3 + L_n(P_n)^3}{L}}$$

- $P_e$**  = Equivalent load (lbf) or (N)
- $P_n$**  = Each increment at different load (lbf) or (N)
- L** = Total distanced traveled per cycle (extend + retract stroke)  
[ $L = L_1 + L_2 + L_3 + L_n$ ]
- $L_n$**  = Each increment of stroke at different load (in) or (mm)



## RE-LUBRICATION RECOMMENDATION:

**IMA33, IMA44, IMA55:** IMA Lubrication requirements for electric actuators depend on the motion cycle (velocity, force, duty cycle), type of application, ambient temperature, environmental surrounding and various other factors.

For many general purpose applications, Tolomatic ball screw actuators are typically considered lubricated for life unless otherwise specified, such as those actuator models outfitted with a re-lubrication feature. For roller screw or ball screw actuators outfitted with a re-lubrication feature, Tolomatic recommends to re-lubricate the actuator at least once per year or every 1,000,000 cycles, whichever comes first, to maximize service life. For more demanding applications such as pressing, high frequency or other highly stressed applications, the re-lubrication interval for these actuators will vary and will need to be more frequent. In these demand-

ing applications, it is recommended to execute at least 5 full stroke moves every 5,000 cycles of operation (or more frequent if possible) to re-distribute the grease within the actuator.

Re-lubricate with Tolomatic Grease #2744-9099 into the grease zerk located on the rod end.

	Quantity	
IMA33	2.5 + [0.010 x L (mm)]	g
IMA44	4.8 + [0.010 x L (mm)]	g
IMA55	6.6 + [0.019 x L (mm)]	g
IMA33	0.09 + [0.009 x L (in)]	oz
IMA44	0.17 + [0.009 x L (in)]	oz
IMA55	0.23 + [0.017 x L (in)]	oz
L=stroke length (mm or in)		

**⚠ In some applications oil may leak from the grease zerk. In contamination sensitive applications replace grease zerk with plug.**

## SIDE LOAD CONSIDERATIONS

The IMA integrated motor actuator is not meant to be used in applications where side loading occurs. Loads must be guided and supported. Loads should be aligned with the line of motion of the thrust rod. Side loading will affect the life of the actuator.

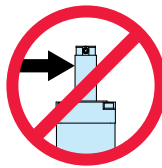

### IMA SIDE LOAD SPECIFICATIONS

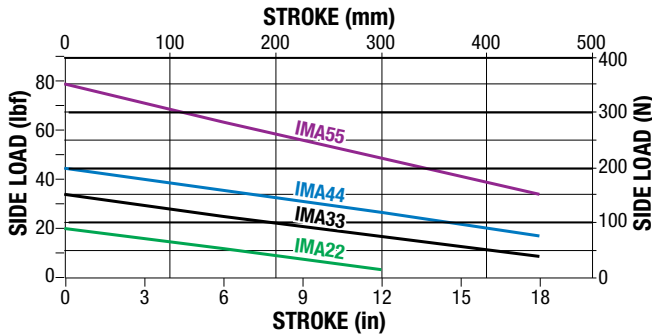

## BRAKE CONSIDERATIONS

In all vertical application an un-powered IMA will require a brake to maintain position. Tolomatic recommends that the nominal back drive force specification (listed on page IMA\_8) be used for reference only. Back drive force is subject to change throughout the life of the actuator, due to mechanical break in, ambient temperature, and duty cycle variation.

A brake can be used with the actuator to keep it from backdriving, typically in vertical applications. A brake may be used for safety reasons or for energy savings allowing the actuator to hold position when un-powered. See page IMA\_23 for ordering information.

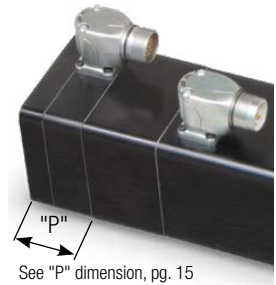

NOTE: The optional Spring-Applied / Electronically-Released Brake requires 24V power. Input current rating:

- IMA22 - 0.35 Amps;
- IMA33 - 0.43 Amps;
- IMA44 - 0.67 Amps;
- IMA55 - 0.66 Amps.

### Brake Specifications:

	SERIES	IMA22	IMA33	IMA44	IMA55
<b>ROTOR INERTIA</b>	gm-cm <sup>2</sup>	19	73	239	214
	oz-in <sup>2</sup>	0.104	0.400	1.307	1.171
<b>CURRENT</b>	Amp	0.35	0.43	0.67	0.66
<b>HOLDING TORQUE</b>	N-m	1.6	4.0	9.0	16.4
	in-lb	14	35	89	145
<b>ENGAGE TIME</b>	mSec	75	40	25	15
<b>DISENGAGE TIME</b>	mSec	20	50	35	25
<b>VOLTAGE</b>	Vdc	24			



USE THE TOLOMATIC SIZING AND SELECTION SOFTWARE AVAILABLE ON-LINE AT [www.tolomatic.com](http://www.tolomatic.com) OR...

CALL TOLOMATIC AT 1-800-328-2174.

We will provide any assistance needed to determine the proper actuator for the job.

# IMA - Integrated Motor Actuator

3D CAD available at [www.tolomatic.com](http://www.tolomatic.com)  
Always use configured CAD solid model  
to determine critical dimensions



Dimensions: **All Sizes**

## DIMENSIONS

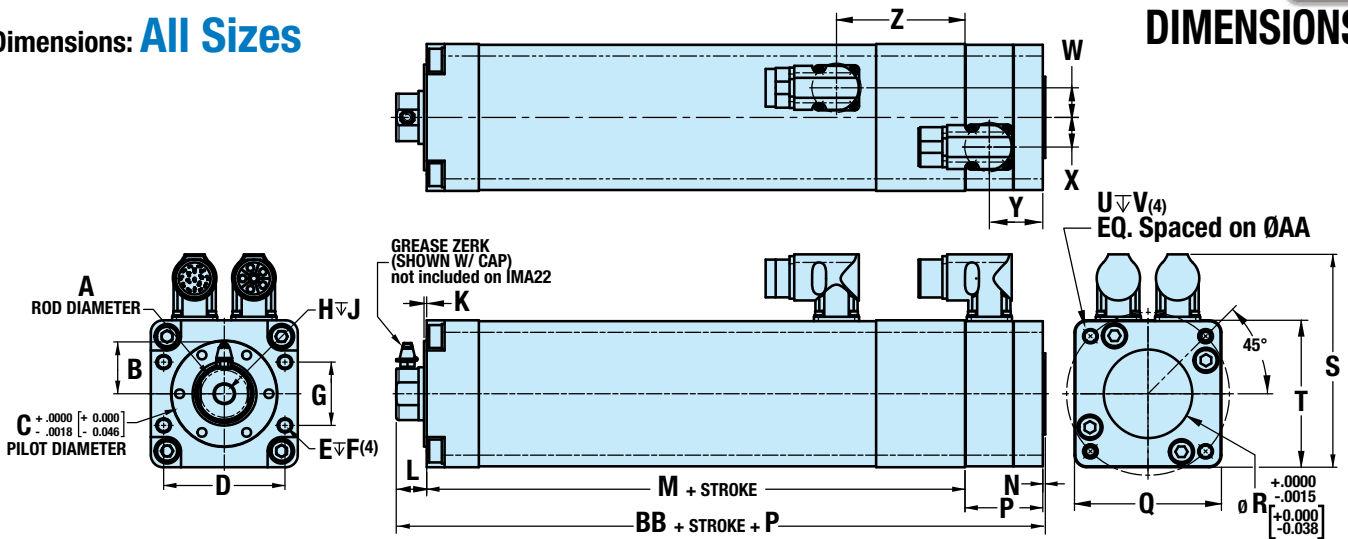

	IMA22	IMA33	IMA44	IMA55
A	25.38	30.13	38.08	57.13
B	-	28.3	32.3	41.9
C	48.000	60.000	72.000	100.000
D	54.00	69.00	85.00	110.00
E	M6 x 1.0	M8 x 1.25	M8 x 1.25	M12 x 1.75
F	13.2	14.5	17.1	22.5
G	20.00	36.00	55.00	65.00
H	M8 x 1.25	M12 x 1.25	M20 x 1.5	M27 x 2.0
J	16.5	22.2	25.9	38.1
K	1.5	1.5	1.5	1.5
L	17.3	17.3	16.8	24.1
M	109.8	153.7	200.0	266.2
N	1.5	1.5	1.5	1.5
P1	41.2	44.2	44.2	48.2
P2	86.7	80.8	80.0	96.8
P3	-	50.3	50.3	54.3
P4	-	93.5	89.0	96.8
P5	41.2	44.2	44.2	59.9
P6	86.7	80.8	80.0	96.8
P7	58.7	59.2	59.2	67.5
P8	96.3	100.6	99.1	111.5
P9	65.1	59.2	63.6	80.5
P10	107.2	100.6	99.1	122.9
Q	63.5	83.6	110.5	143.6
R	40.000	50.000	75.000	100.000
S1	104.4	124.6	151.4	184.3
S2	102.0	122.2	149.0	181.9
S3	-	113.5	140.4	173.3
T	63.5	83.6	110.5	143.6
U	M6 x 1.0	M8 x 1.25	M8 x 1.25	M12 x 1.75
V	13.5	16.5	16.5	20.5
W	9.5	16.8	22.2	22.2
X	9.5	16.8	22.2	22.2
Y	27.3	30.4	30.4	34.4
Z	60.6	73.1	77.9	86.9
AA	70.00	92.00	127.00	155.00
BB	128.6	172.5	218.3	291.8

	IMA22	IMA33	IMA44	IMA55
A	0.999	1.186	1.499	2.249
B	-	1.11	1.27	1.65
C	1.8898	2.3622	2.8346	3.937
D	2.126	2.717	3.346	4.331
E	-	-	-	-
F	0.52	0.57	0.68	0.89
G	0.787	1.417	2.165	2.559
H	-	-	-	-
J	0.65	0.88	1.02	1.50
K	0.06	0.06	0.06	0.06
L	0.68	0.68	0.66	0.95
M	4.32	6.05	7.88	10.48
N	0.06	0.06	0.06	0.06
P1	1.62	1.74	1.74	1.90
P2	3.41	3.18	3.15	3.81
P3	-	1.98	1.98	2.14
P4	-	3.68	3.50	3.81
P5	1.62	1.74	1.74	2.36
P6	3.41	3.18	3.15	3.81
P7	2.31	2.33	2.33	2.66
P8	3.79	3.96	3.90	4.39
P9	2.56	2.33	2.50	3.17
P10	4.22	3.96	3.90	4.84
Q	2.50	3.29	4.35	5.66
R	1.5748	1.9685	2.9528	3.937
S1	4.11	4.91	5.96	7.26
S2	4.02	4.81	5.87	7.16
S3	-	4.47	5.53	6.82
T	2.50	3.29	4.35	5.66
U	-	-	-	-
V	0.53	0.65	0.65	0.80
W	0.38	0.66	0.88	0.88
X	0.38	0.66	0.88	0.88
Y	1.08	1.20	1.20	1.35
Z	2.39	2.88	3.07	3.42
AA	2.756	3.622	5.000	6.102
BB	5.06	6.79	8.6	11.49

## KEY FEATURES: 1-STACK & 3-STACK MOTORS

### IMA22

SERIES		MV21/41	MV23/43
STROKE	mm	76.2 to 304.8	152.4 to 304.8
	in	3.0 to 12.0	6.0 to 12.0
PEAK THRUST	N	up to 1,446	up to 1,446
	lbf	up to 325	up to 325

### IMA33

SERIES		MV21/41	MV23/43
STROKE	mm	76.2 to 457.2	152.4 to 457.2
	in	3.0 to 18.0	6.0 to 18.0
PEAK THRUST	N	up to 4,673	up to 11,100
	lbf	up to 1,050	up to 2,500

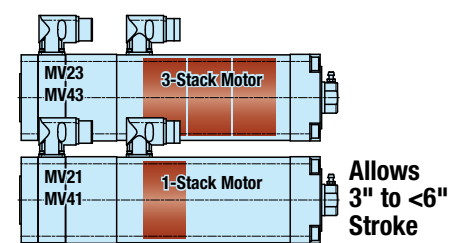

Dimensions in millimeters

P1 =	Dx1 D1N	Digital Encoder
P2 =	Dx1 D1B	Digital Encoder with Brake
P3 =	DE2 D1N	*Digital Encoder (Nidec/Control Techniques NT)
P4 =	DE2 D1B	*Digital Encoder (Nidec/Control Techniques NT) w/ Brake
P5 =	Dx1 R1N	Resolver
P6 =	Dx1 R1B	Resolver with Brake

Dimensions in inches

P7 =	Dx1 A1N DA2 A2N	SICK Hiperface SICK Hiperface DSL
P8 =	Dx1 A1B DA2 A2B	SICK Hiperface w/ Brake SICK Hiperface DSL w/ Brake
P9 =	Dx1 H4N	Heidenhain Endat 2.2
P10 =	Dx1 H4B	Heidenhain Endat 2.2 w/ Brake
S1 =	DT1, DE1 DL1, DS1	Tolomatic Standard, Nidec/Control Techniques FM, Lenze, Siemens

S2 =	DB1	Bosch MSK Motor Series
S3 =	DE2	Nidec/Control Techniques NT Series

\*Uses Box Mount Connectors (IP67 not available)  
Not available as standard on IMA22



## Dimensions: Rod End Options

### EXTERNAL THREADED ROD END (MET)

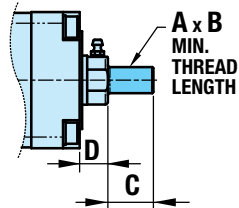
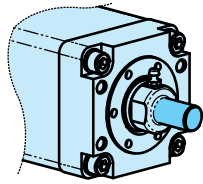

### CLEVIS ROD END (RCL)

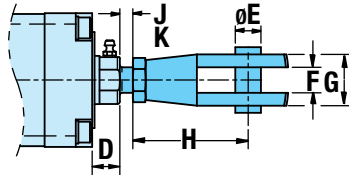
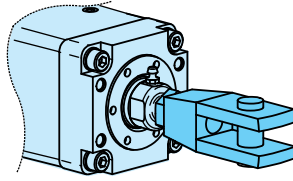

### SPHERICAL ROD EYE (SRE)

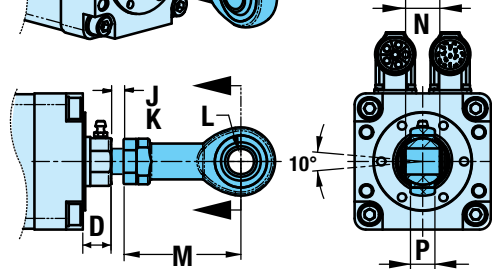
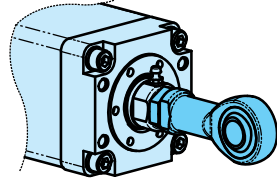

### ALIGNMENT COUPLER (ALC + MET)

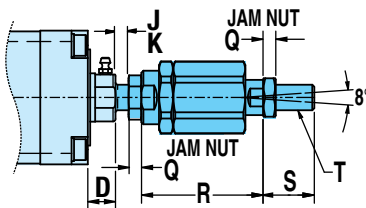
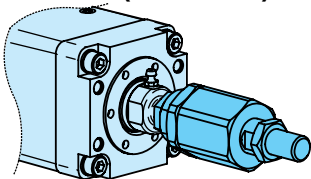

### ALIGNMENT COUPLER FEMALE (ALC)\*

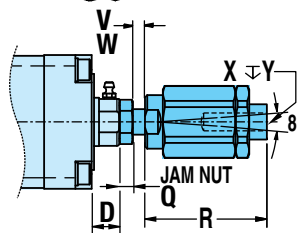
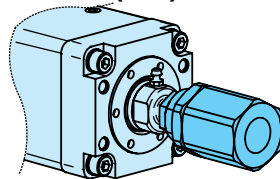

\*For IMA44 & IMA55 Only

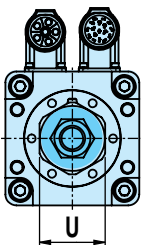

	IMA22	IMA33	IMA44	IMA55
A	M10 x 1.25	M16 x 1.5	M20 x 1.5	M27 x 2.0
B	22.1	34.3	41.4	38.1
C	24.6	37.3	44.5	50.8
D	17.3	17.3	16.8	24.1
E	10.00	16.00	20.00	30.00
F	10.0	16.0	20.0	30.0
G	20.0	32.0	40.0	55.0
H	45.0	72.0	90.0	123.5
J	9.1	13.2	14.2	10.1
K	2.5	3.0	3.0	5.1
L	10.00	16.00	20.00	30.00
M	48.0	72.0	87.0	123.5
N	14.0	21.0	25.0	37.0
P	12.5	15.0	18.0	25.0
Q	5.0	8.0	10.0	13.5
R	53.0	76.0	82.0	93.0
S	20.0	32.0	40.0	54.0
T	M10 x 1.25	M16 x 1.5	M20 x 1.5	M27 x 2.0
U	30.0	41.0	42.0	55.0
V	-	-	11.0	11.0
W	-	-	4.1	2.4
X	-	-	M20 x 1.5	M27 x 1.75
Y	-	-	42.0	54.0

Dimensions in millimeters

	IMA22	IMA33	IMA44	IMA55
A	-	-	-	-
B	0.87	1.35	1.63	1.80
C	0.97	1.47	1.75	2.00
D	0.68	0.68	0.66	0.95
E	0.394	0.630	0.787	1.181
F	0.39	0.63	0.79	1.18
G	0.79	1.26	1.57	2.17
H	1.77	2.83	3.54	4.86
J	0.36	0.52	0.56	0.40
K	0.10	0.12	0.12	0.20
L	0.394	0.630	0.787	1.181
M	1.89	2.84	3.43	4.86
N	0.55	0.83	0.98	1.46
P	0.49	0.59	0.71	0.94
Q	0.20	0.32	0.39	0.53
R	2.09	2.99	3.23	3.66
S	0.79	1.26	1.57	2.16
T	-	-	-	-
U	1.18	1.61	1.65	2.17
V	-	-	0.43	0.43
W	-	-	0.16	0.09
X	-	-	-	-
Y	-	-	1.65	2.13

Dimensions in inches





## Dimensions: Mounting Options

## DIMENSIONS

### FRONT FLANGE MOUNT (FFG)

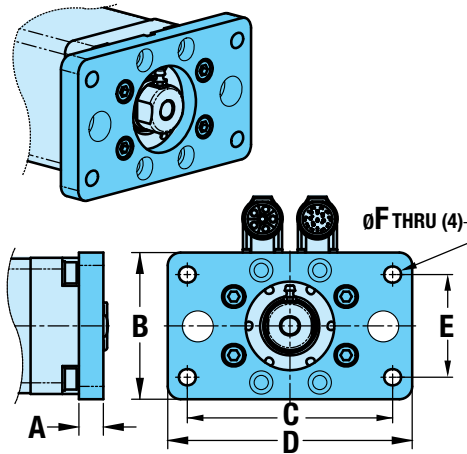

### FRONT TRUNNION MOUNT (TRF)

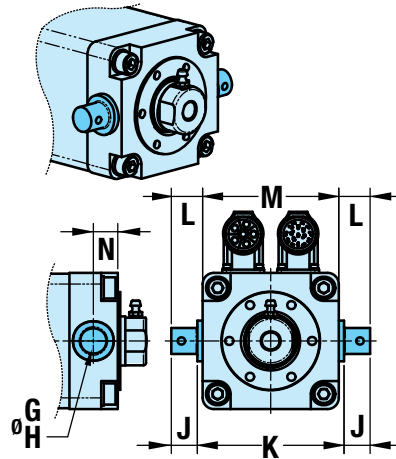

	IMA22	IMA33	IMA44	IMA55
A	11.2	15.0	16.0	17.8
B	67.3	87.0	110.5	150.0
C	100.00	126.00	150.00	230.00
D	117.3	150.0	170.0	260.0
E	50.00	63.00	75.00	115.00
F	8.7	12.3	14.7	16.7
G	11.99	15.98	19.99	24.99
H	11.96	15.95	19.96	24.97
J	8.6	16.0	20.1	24.9
K	68.0	90.0	123.0	160.0
L	10.9	19.2	26.3	33.1
M	63.5	83.6	110.5	143.6
N	15.0	15.0	21.0	28.0
Q	26.000 <sup>1</sup>	32.000	50.000	60.000
R	45.000 <sup>2</sup>	60.000	90.000	110.000 <sup>4</sup>
S	10.000 <sup>3</sup>	12.000	16.000	20.000 <sup>5</sup>
T	20.00	24.00	36.00	40.00
U	13.00	16.00	22.00	27.00
V	11.99	15.98	19.99	24.99
W	11.96	15.95	19.96	24.97
X	8.6	16.0	20.1	24.9
Y	68.0	90.0	123.0	160.0
Z	10.9	19.2	26.3	33.1
AA	63.5	83.6	110.5	143.6
BB	15.0	20.0	25.0	32.0

Dimensions in millimeters

### REAR CLEVIS MOUNT (PCD)

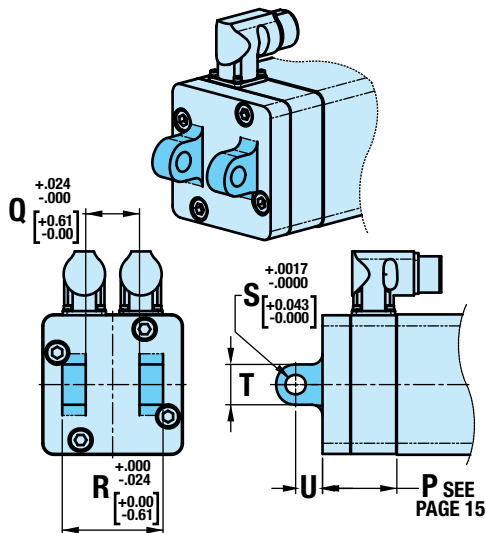

1	+0.520mm/-0.000mm
2	+0.000mm/-0.620mm
3	+0.036mm/-0.000mm
4	+0.000mm/-0.870mm
5	+0.052mm/-0.000mm

	IMA22	IMA33	IMA44	IMA55
A	0.44	0.59	0.63	0.70
B	2.65	3.43	4.35	5.91
C	3.937	4.961	5.906	9.055
D	4.62	5.91	6.69	10.24
E	1.969	2.480	2.953	4.528
F	0.34	0.48	0.58	0.66
G	0.472	0.629	0.787	0.984
H	0.471	0.628	0.786	0.983
J	0.34	0.63	0.79	0.98
K	2.68	3.54	4.84	6.30
L	0.43	0.76	1.04	1.30
M	2.50	3.29	4.35	5.66
N	0.59	0.59	0.83	1.10
Q	1.0236 <sup>1</sup>	1.2598	1.9685	2.3622
R	1.7717 <sup>2</sup>	2.3622	3.5433	4.3307 <sup>4</sup>
S	0.3937 <sup>3</sup>	0.4724	0.6299	0.7874 <sup>5</sup>
T	0.787	0.945	1.417	1.575
U	0.512	0.630	0.866	1.063
V	0.472	0.629	0.787	0.984
W	0.471	0.628	0.786	0.983
X	0.34	0.63	0.79	0.98
Y	2.68	3.54	4.84	6.30
Z	0.43	0.76	1.04	1.30
AA	2.50	3.29	4.35	5.66
BB	0.59	0.79	0.98	1.26

Dimensions in inches

### REAR TRUNNION MOUNT (TRR)

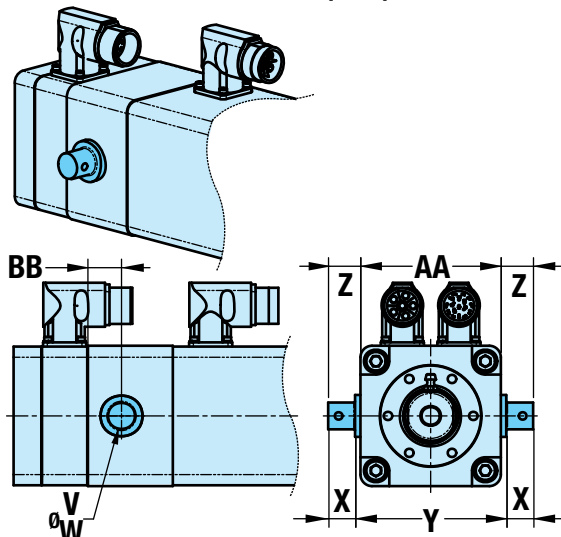

1	+0.0205"/-0.0000"
2	+0.0000"/-0.0244"
3	+0.0014"/-0.0000"
4	+0.0000"/-0.0343"
5	+0.0020"/-0.0000"

# IMA - Integrated Motor Actuator

3D CAD available at [www.tolomatic.com](http://www.tolomatic.com)  
Always use configured CAD solid model  
to determine critical dimensions



## Dimensions: Options

### SIDE MOUNTING (MST)

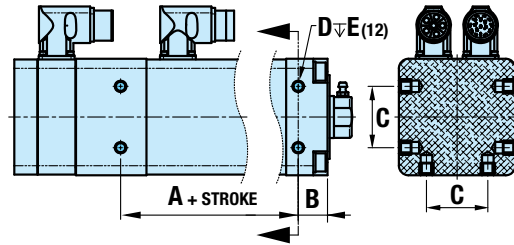
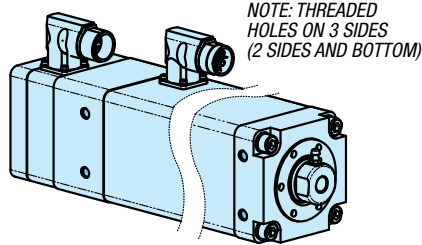

### MOUNTING PLATES (MP2)

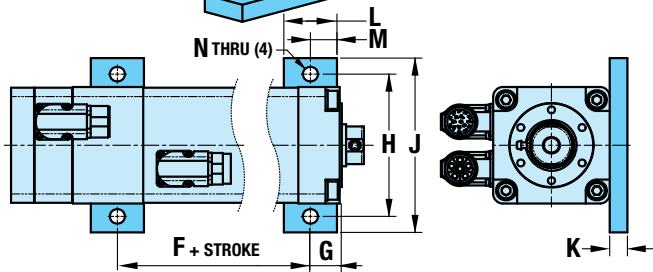
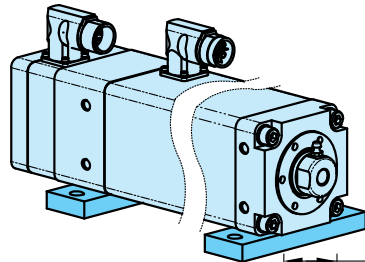

### ANTI ROTATE (ARO)

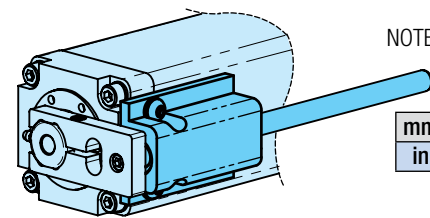

NOTE: When ARO is used together with FFG, stroke is reduced by dimension below

	IMA22	IMA33	IMA44	IMA55
mm	7.6	11.4	13.0	11.2
in	0.30	0.45	0.51	0.44

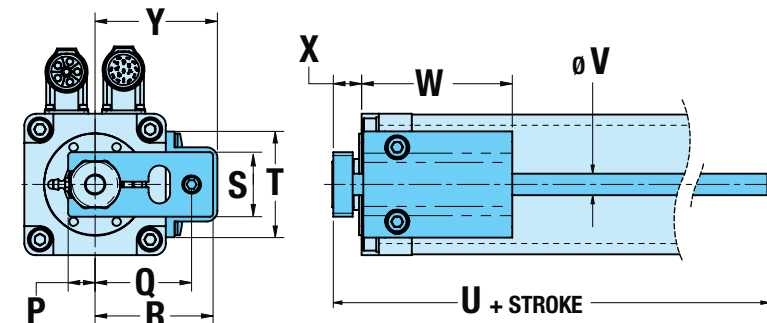

	IMA22	IMA33	IMA44	IMA55
A	67.8	100.7	143.0	191.2
B	20.0	21.0	25.0	30.0
C	34.00	44.00	50.00	85.00
D	M6 X 1.0	M8 x 1.25	M8 x 1.25	M12 x 1.75
E	13.1	14.5	17.1	22.5
F	67.8	100.7	143.0	191.2
G	20.0	21.0	25.0	30.0
H	80.00	102.00	130.00	170.00
J	100.0	125.0	155.0	200.0
K	11.0	12.7	12.7	20.0
L	30.0	38.1	38.1	50.0
M	15.0	19.1	19.1	0.5
N	8.7	10.7	10.7	15.1
P	12.7	15.9	19.8	31.8
Q	43.3	57.0	70.5	95.1
R	51.2	69.7	83.2	109.7
S	34.8	38.1	45.9	68.2
T	46.2	62.7	62.7	106.7
U	81.0	105.2	108.5	142.5
V	9.5	12.7	12.7	19.1
W	65.0	89.0	93.0	115.6
X	16.1	16.1	15.5	22.8
Y	54.9	72.3	85.7	118.3

Dimensions in millimeters

	IMA22	IMA33	IMA44	IMA55
A	2.67	3.97	5.63	7.53
B	0.79	0.83	0.98	1.18
C	1.339	1.732	1.969	3.346
D	-	-	-	-
E	0.52	0.57	0.68	0.89
F	2.67	3.97	5.63	7.53
G	0.79	0.83	0.98	1.18
H	3.150	4.016	5.118	6.693
J	3.94	4.92	6.10	7.87
K	0.43	0.50	0.50	0.79
L	1.18	1.50	1.50	1.97
M	0.59	0.75	0.75	0.98
N	0.34	0.42	0.42	0.59
P	0.50	0.63	0.78	1.25
Q	1.71	2.24	2.78	3.74
R	2.02	2.75	3.28	4.32
S	1.37	1.50	1.81	2.69
T	1.82	2.47	2.47	4.20
U	3.19	4.14	4.27	5.60
V	0.38	0.50	0.50	0.75
W	2.56	3.50	3.66	4.55
X	0.63	0.63	0.61	0.90
Y	2.16	2.85	3.38	4.66

Dimensions in inches

# The IMA is matched to your drive/controller choice

The IMA has been successfully integrated with the following servo drive/controller and robot companies:

#### Controller/ Drive Manufacturers

- Aerotech BM\*
- Allen Bradley MP & VP
- B&R 8LS\*
- Baldor BSM
- Beckhoff AM8\*
- Bosch Rexroth MSK
- Kollmorgen AKM\*
- Lenze MCA
- Nidec/Control Techniques FM & NT
- Omron\*
- Parker MPP\*
- Schneider Electric SH\*
- SEW CMP\*
- Siemens 1F
- Stober\*
- Others

#### Robot Manufacturers

- ABB\*
- Fanuc\*
- Kawasaki\*
- Kuka\*
- Motoman\*
- Nachi\*
- Others

\* Consult Tolomatic for lead time

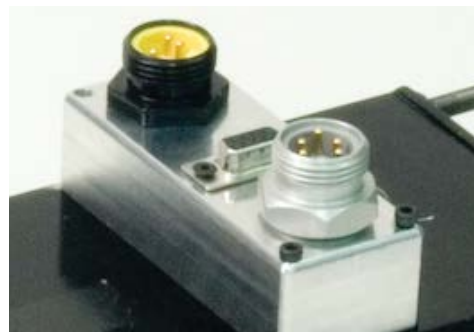

Contact Tolomatic if your preferred servo drive/controller or robot supplier is not listed above.



Licensed Partner

For additional information regarding the integration of the IMA to an Allen Bradley/Rockwell drive see tech note linked below:

[3600-4187 TN IMA-AB-servo.pdf](#)

# The IMA is the most rigorously tested Tolomatic product yet

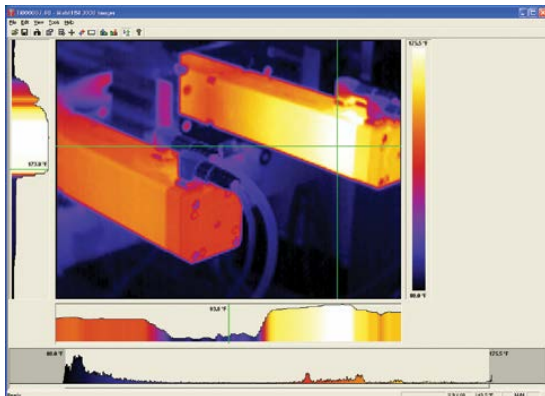

Cutting edge products like the IMA don't just fall into place. Over 20,000 hours of testing were required to prove the design that ships today. Thermal imaging, dynamic loading and other state-of-the-art techniques give us the confidence to stand behind our published performance data.



## Selection Guidelines

### 1 ESTABLISH MOTION PROFILE

Using the application stroke length, desired cycle time and loads establish the motion profile details.

### 2 COMPARE OPERATING (PEAK) THRUST AND SPEED TO OPERATING REGION

Calculate the application required operating (peak) thrust and speed and compare to tables on pages IMA\_8-9. The calculated thrust and speed must fall within the operating region of the actuator.

### 3 COMPARE SEVERE DUTY (CONTINUOUS) THRUST AND SPEED TO SEVERE DUTY REGION

Calculate the RMS thrust and speed required and compare to tables on pages IMA\_8-9. The calculated thrust and speed must fall within the severe duty region. See complete instructions on page IMA\_14 for help calculating continuous force.

$$T_{RMS} = \sqrt{\frac{\sum (T_i^2 \times t_i)}{\sum (t_i)}} \quad v_{RMS} = \sqrt{\frac{\sum (V_i^2 \times t_i)}{\sum (t_i)}}$$

### 4 CONSIDER SCREW/NUT CHOICES

Choose roller nuts for its longer life (see Life graph on page IMA\_13) and higher peak loads (see graphs on pages IMA\_10 & 11). Ball nuts are cost competitive and more efficient (see table on page IMA\_8).

#### SCREW ACCURACY

Roller Nut	± 0.0004"/ft.	± 0.0102mm/300mm
Ball Nut	± 0.002"/ft.	± 0.051mm/300mm

### 5 VERIFY CRITICAL SPEED OF THE SCREW

Verify that the application's peak linear velocity does not exceed the critical speed value for the size and lead of the screw selected.

### 6 VERIFY AXIAL BUCKLING STRENGTH OF THE SCREW (ROLLER SCREW)

Verify that the peak thrust does not exceed the critical buckling force for the size of the screw selected.

### 7 MOTOR WINDINGS & VOLTAGES

Choose motor windings optimized for 230 Vac and 460 Vac voltage busses. The 1 stack motor (MV21-230V & MV41-460V), available for the IMA22/33, allows strokes between 3 and 6" providing the thrust needed for many applications in a more compact, lighter weight package

### 8 CALCULATE LUBRICATION INTERVAL

See page IMA\_14 for an overview and IMA Users Guide (#2700-4001) for complete instructions to calculate lubrication interval.

### 9 TEMPERATURE

The IMA is intended to operate in an environment with an ambient temperature between 50-104°F, (10-40°C). Performance should be de-rated if the ambient temperature is above 77°F (25°C). Contact the factory if the ambient temperature does not fit within this range. NOTE: Temperature of the actuator's body can approach 180°F (82°C) in aggressive

applications. Adequate clearance to ensure actuator's ambient conditions do not rise drastically should be allowed.

### 10 BRAKE CONSIDERATIONS

In all vertical application an unpowered IMA will require a brake to maintain position. Tolomatic recommends that the nominal back drive force specification be used for reference only. Back drive force is subject to change throughout the life of the actuator, due to mechanical break in, ambient temperature, and duty cycle variation.

A brake can be used with the actuator to keep it from back-driving, typically in vertical applications. A brake may be used for safety reasons or for energy savings allowing the actuator to hold position when un-powered. See page IMA\_23 for ordering information.

NOTE: The optional Spring-Applied/Electronically Released Brake requires 24V power. Input current rating:  
IMA22 - 0.35Amps; IMA33 - 0.43 Amps;  
IMA44 - 0.67 Amps; IMA55 - 0.66 Amps.

### 11 CHOOSE MOTOR CONNECTORS & FEEDBACK DEVICE

Connector choice and wiring emulates popular motor manufacturers for compatibility.

Current connector choices include:

- Bosch Rexroth MSK Series
- Control Techniques FM & NT
- Lenze MCA Series

Current feedback choices include:

- Incremental Encoder
- Absolute Encoder, Hiperface, Hiperface DSL, EnDat 2.2
- Resolver

Contact Tolomatic for additional motor connectors, feedback combinations and motor files for third party drives.

### 12 CONSIDER MOUNTING & ROD END OPTIONS

Examine mounting options dimensional drawings on page IMA\_15-18. Standard mounting on the IMA are 4 tapped holes on the front rod end face of the actuator. The Side Mount option (MST) includes 12 tapped holes, 4 on each side and 4 on the bottom of the actuator. Other fixed mounting options are the Front Flange Mount (FFG) and Mounting Plates (MP2). Pivoting mount options are Front Trunnion (TRF), Rear Trunnion (TRR) and Rear Clevis Mount (PCD).

Rod End Options include: External Threaded Rod End (MET), Clevis Rod End (RCL), Spherical Rod Eye (SRE) and Alignment Coupler (ALC).

NOTE: Regardless of the mounting option chosen, care must be taken to ensure that the load is guided and in-line with the thrust rod's line of motion. Misalignment of the thrust rod's line of motion will cause degradation in the actuator's expected life.

### 13 CONSIDER ENVIRONMENTAL RATING AND ANTI-ROTATE OPTIONS

The environmental rating for a standard IMA is IP65, choose IP67 for protection against water and dust ingress. Choose the Anti-Rotate Option (ARO) if required. Call Tolomatic at 1-800-328-2174 for help in determining the best actuator for your application.



# APPLICATION DATA WORKSHEET Fill in known data. Not all information is required for all applications



sizeit.tolomatic.com  
for fast, accurate  
actuator selection

## ORIENTATION

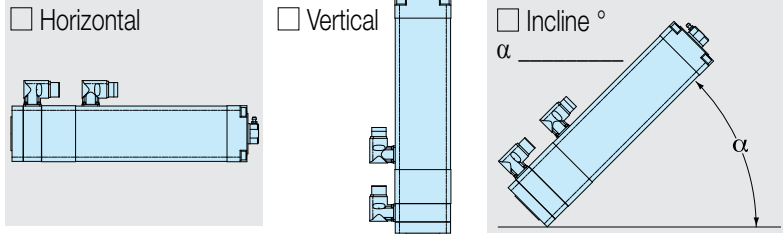

Load supported by actuator    OR     Load supported by other mechanism

## MOVE PROFILE

### EXTEND

Move Distance \_\_\_\_\_

inch       millimeters

Move Time \_\_\_\_\_ sec

Max. Speed \_\_\_\_\_

in/sec       mm/sec

Dwell Time After Move \_\_\_\_\_ sec

### RETRACT

Move Distance \_\_\_\_\_

inch       millimeters

Move Time \_\_\_\_\_ sec

Max. Speed \_\_\_\_\_

in/sec       mm/sec

Dwell Time After Move \_\_\_\_\_ sec

## NO. OF CYCLES

per minute       per hour

## HOLD POSITION?

Required

Not Required

After Move

During Power Loss

## STROKE LENGTH

order in \_\_\_\_\_  
mm ONLY       millimeters (S M)  
(Metric)

**NOTE:** If load or force changes during cycle use the highest numbers for calculations

### EXTEND

#### LOAD

lb       kg  
(U.S. Standard)      (Metric)

#### FORCE

lbf       N  
(U.S. Standard)      (Metric)

### RETRACT

#### LOAD

lb       kg  
(U.S. Standard)      (Metric)

#### FORCE

lbf       N  
(U.S. Standard)      (Metric)

## PRECISION

Repeatability \_\_\_\_\_

inch       millimeters

## OPERATING ENVIRONMENT

Temperature, Contamination, Water, etc.

\_\_\_\_\_

\_\_\_\_\_

\_\_\_\_\_

## MOTION PROFILE

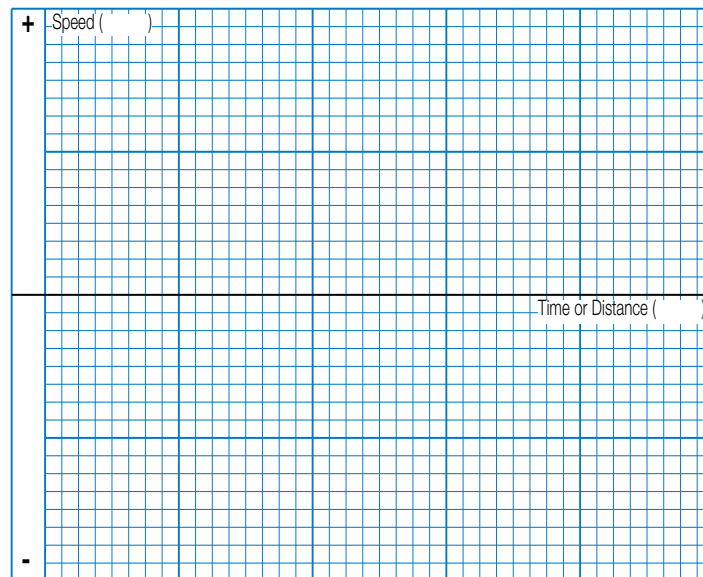

Graph your most demanding cycle, including accel/decel, velocity and dwell times. You may also want to indicate load variations and I/O changes during the cycle. Label axes with proper scale and units.

## CONTACT INFORMATION

Name, Phone, Email  
Co. Name, Etc.

\_\_\_\_\_

\_\_\_\_\_

\_\_\_\_\_



**USE THE TOLOMATIC SIZING AND SELECTION SOFTWARE AVAILABLE ON-LINE AT [www.tolomatic.com](http://www.tolomatic.com) OR... CALL TOLOMATIC AT 1-800-328-2174.** We will provide any assistance needed to determine the proper actuator for the job.

FAX 1-763-478-8080

EMAIL [help@tolomatic.com](mailto:help@tolomatic.com)

# IMA - Integrated Motor Actuator

## Replacement Option Parts Ordering

PART NO.	DESCRIPTION
2722-9014	Spherical Rod Eye Kit, IMA22
2733-9014	Spherical Rod Eye Kit, IMA33
2744-9014	Spherical Rod Eye Kit, IMA44
2755-9014	Spherical Rod Eye Kit, IMA55
2722-9015	Clevis Rod End Kit, IMA22
2733-9015	Clevis Rod End Kit, IMA33
2744-9015	Clevis Rod End Kit, IMA44
2755-9015	Clevis Rod End Kit, IMA55
2124-1070	Alignment Coupler Kit, IMA22
2132-1060	Alignment Coupler Kit, IMA33
2150-1060	Alignment Coupler Kit, IMA44
2164-1060	Alignment Coupler Kit, IMA55
2722-9010	Mounting Plate Kit, IMA22
2733-9010	Mounting Plate Kit, IMA33
2744-9010	Mounting Plate Kit, IMA44
2755-9010	Mounting Plate Kit, IMA55
2722-9018	Front Flange Mount Kit, IMA22
2733-9018	Front Flange Mount Kit, IMA33
2744-9018	Front Flange Mount Kit, IMA44
2755-9018	Front Flange Mount Kit, IMA55
2722-2045	Rear Clevis Mount, IMA22
2733-1045	Rear Clevis Mount, IMA33
2744-1045	Rear Clevis Mount, IMA44
2755-1045	Rear Clevis Mount, IMA55
2722-9075	Anti Rotate, Bearing Assy, IMA22
2733-9075	Anti Rotate, Bearing Assy, IMA33 & 44
2755-9075	Anti Rotate, Bearing Assy, IMA55
2722-9074	Anti Rotate, Shaft Clamp Assy, IMA22
2722-2211	Anti Rotate, Shaft, IMA22 - Indicate Stroke
2733-9074	Anti Rotate, Shaft Clamp Assy, IMA33
2733-1211	Anti Rotate, Shaft, IMA33 - Indicate Stroke
2744-9074	Anti Rotate, Shaft Clamp Assy, IMA44
2744-1211	Anti Rotate, Shaft, IMA44 - Indicate Stroke

PART NO.	DESCRIPTION
2755-9074	Anti Rotate, Shaft Clamp Assy, IMA55
2755-1211	Anti Rotate, Shaft, IMA55 - Indicate Stroke
2733-1611	Motor Power Cable, M23, 6 Pin, 5m, 460V AC
2733-1612	Motor Power Cable, M23, 6 Pin, 5m, 460V AC, Brake
2733-1613	Encoder Cable, M23, 12 Pin, 5m, Resolver/Absolute
2733-1614	Encoder Cable, M23, 17 Pin, 5m, Incremental
2744-1488	Motor Power Cable, M23, 6 Pin, 5m, 230V AC
2744-1489	Motor Power Cable, M23, 6 Pin, 5m, 230V AC, Brake
2733-1221	Motor Power Cable, M23, 6 Pin, 10m, 460V AC
2733-1222	Motor Power Cable, M23, 6 Pin, 10m, 460V AC, Brake
2733-1223	Encoder Cable, M23, 12 Pin, 10m, Resolver/Absolute
2733-1224	Encoder Cable, M23, 17 Pin, 10m, Incremental
2744-1221	Motor Power Cable, M23, 6 Pin, 10m, 230V AC
2744-1222	Motor Power Cable, M23, 6 Pin, 10m, 230V AC, Brake
2744-1016	Mobilith SHC220 Grease (Ball nut/screw)
2744-9099	Grease (Roller nut/screw)
2552-1132	Wiper, IMA22
2115-1030	Wiper, IMA33
2744-1003	Wiper, IMA44
2140-1030	Wiper, IMA55
2744-1213	Zerk Cap
2744-9092	Kit, Zerk with Cap
2744-1214	Grease Ftg. Plug

All parts are listed for REPLACEMENT ONLY. If not ordered on original unit the IMA may require additional tapped holes or replacement rod end. Contact Tolomatic.

\*Not valid with DA2A2X option



# IMA - Integrated Motor Actuator

## Ordering

MODEL SELECTION (MUST BE IN THIS ORDER)

**IMA 44 BN05 SM304-8 MV23 DT1D1 N**

OPTIONS (IN ANY ORDER)

**ALC MP2 IP67 CR5**

**MODEL**

**IMA** Integrated Motor Actuator

**IMAWP\*** Integrated Motor Actuator

\*IMAWP: lead time will vary from standard 15 day delivery, contact Tolomatic

**SIZE**

**22** 22 Series Actuator

**33** 33 Series Actuator

**44** 44 Series Actuator

**55** 55 Series Actuator

**NUT / SCREW**

Screw/Nut combinations available

22	33	44	55	Description
BN05	BN05	BN05	BN05	Ball Nut, 5 mm lead
BN10	BN10	BN10	BN10	Ball Nut, 10 mm lead
—	BN20	—	BN20	Ball Nut, 20 mm lead
—	—	BN25	—	Ball Nut, 25 mm lead
—	RN04	RN04	—	Roller Nut, 4 mm lead
—	RN05	RN05	RN05	Roller Nut, 5 mm lead
—	RN10	RN10	RN10	Roller Nut, 10 mm lead

**STROKE LENGTH**

**SM** Stroke, (76.2 to 457.2) enter stroke length in millimeters

*NOTE: Maximum stroke for IMA22 is 12" (304.8 mm)*

**MOTOR VOLTAGE**

**MV21\*** 230 Vac, Motor Voltage, 1 Stack Winding

**MV41\*** 460 Vac, Motor Voltage, 1 Stack Winding

**MV23** 230 Vac, Motor Voltage, 3 Stack Winding

**MV43** 460 Vac, Motor Voltage, 3 Stack Winding

*NOTE: 22/33 size actuators only*

**BRAKE OPTION**

**N** NO Brake

**B** Brake

**ROD END OPTIONS**

— **Standard**, female, internally threaded rod end

**MET** Male Externally Threaded Rod End

**SRE** Spherical Eye Rod End

**RCL** Clevis Rod End

**ALC** Alignment Coupler\*

*NOTE: For IMA44 & IMA55 Only ALC (Alignment Coupler) requires ARO (Anti-Rotate) for proper operation*

**MOUNTING OPTIONS**

— **Standard Face Mount**

**MP2** Mounting Plates - 2 req.

**FFG** Front Flange Mount

**TRF** Trunnion Mount, Front

**TRR** Trunnion Mount, Rear

**PCD** Clevis Mount, Rear

**MST** Side Mount (tapped holes on 3 sides)

**OTHER OPTIONS**

**IP67\*\*** Ingress Protection Rating

**ARO** Anti Rotate

**LUB** Food Grade Grease

*\*\*IP67 is not available with DE2 (Control Techniques NT connectors) Not available on any IMA22*

**CABLES**

**Tolomatic standard**

**CR5** 6m flying lead cables, power and feedback

**Tolomatic standard**

**CR10** 10m flying lead cables, power and feedback

For custom cable lengths please contact Tolomatic. Lead times will vary.

*NOTE: only use these cable options with DT1 motor connector, use cables from drive manufacturer for all others.*

For IP rated cables contact Tolomatic

MOTOR SERIES CONNECTORS	FEEDBACK DEVICE
Allen Bradley MP <b>DA1</b>	<b>A1</b> SICK Hiperface
Allen Bradley VP <b>DA2</b>	<b>A2</b> SICK Hiperface DSL
Bosch Rexroth MSK <b>DB1</b>	<b>A1</b> SICK Hiperface
Nidec/Cntl. Tech., FM <b>DE1</b>	<b>A1</b> SICK Hiperface
Nidec/Cntl. Tech., FM <b>DE1</b>	<b>R1</b> Resolver
Nidec/Cntl. Tech., FM <b>DE1</b>	<b>D1</b> Incremental
Nidec/Cntl. Tech., NT <b>DE2</b>	<b>D1</b> Incremental
Lenze MCS <b>DL1</b>	<b>A1</b> SICK Hiperface
Lenze MCS <b>DL1</b>	<b>R1</b> Resolver
Lenze MCS <b>DL1</b>	<b>D1</b> Incremental

MOTOR SERIES CONNECTORS	FEEDBACK DEVICE
Siemens 1F <b>DS1</b>	<b>H4</b> Heidenhain Endat 2.2
Tolomatic Standard <b>DT1</b>	<b>D1</b> Incremental
Tolomatic Standard <b>DT1</b>	<b>R1</b> Resolver
Tolomatic Standard <b>DT1</b>	<b>A1</b> SICK Hiperface
Tolomatic Standard <b>DT1</b>	<b>H1</b> Heidenhain Endat 2.2
Motor Connector or Feedback Device Not Shown <b>DX</b>	***See below

\*\*\* Tolomatic can configure the IMA to connect to a drive using cables from other leading drive manufactures including but not limited to those listed below.

ABB	Fanuc	Motoman	SEW
Aerotech	Kawasaki	Nachi	Stober
B&R	Kollmorgen	Omron	Others
Baldor	Kuka	Parker	
Beckhoff	Lenze	Schneider Electric	

This integration includes customer specified motor thermal protection, feedback, connectors, flying lead/connectorized extension cables and motor alignment.

For more information about combinations not listed above, or other customizations, contact Tolomatic.



[tolomatic.com/CAD](http://tolomatic.com/CAD)  
Download 3D CAD  
Always use CAD solid model to determine critical dimensions



[tolomatic.com/ask](http://tolomatic.com/ask)  
Technical support before and after purchase

# The Tolomatic Difference Expect More From the Industry Leader:



## INNOVATIVE PRODUCTS

Solutions with Endurance Technology<sup>SM</sup> for challenging applications.



## FAST DELIVERY

Built-to-order with configurable stroke lengths and flexible mounting options.



## ACTUATOR SIZING

Size and select electric actuators with our online software.



## YOUR MOTOR HERE<sup>®</sup>

Match your motor to compatible mounting plates with Tolomatic actuators.



## CAD LIBRARY

Download 2D or 3D CAD files for Tolomatic products.



## TECHNICAL SUPPORT

Get a question answered or request a virtual design consultation with one of our engineers.

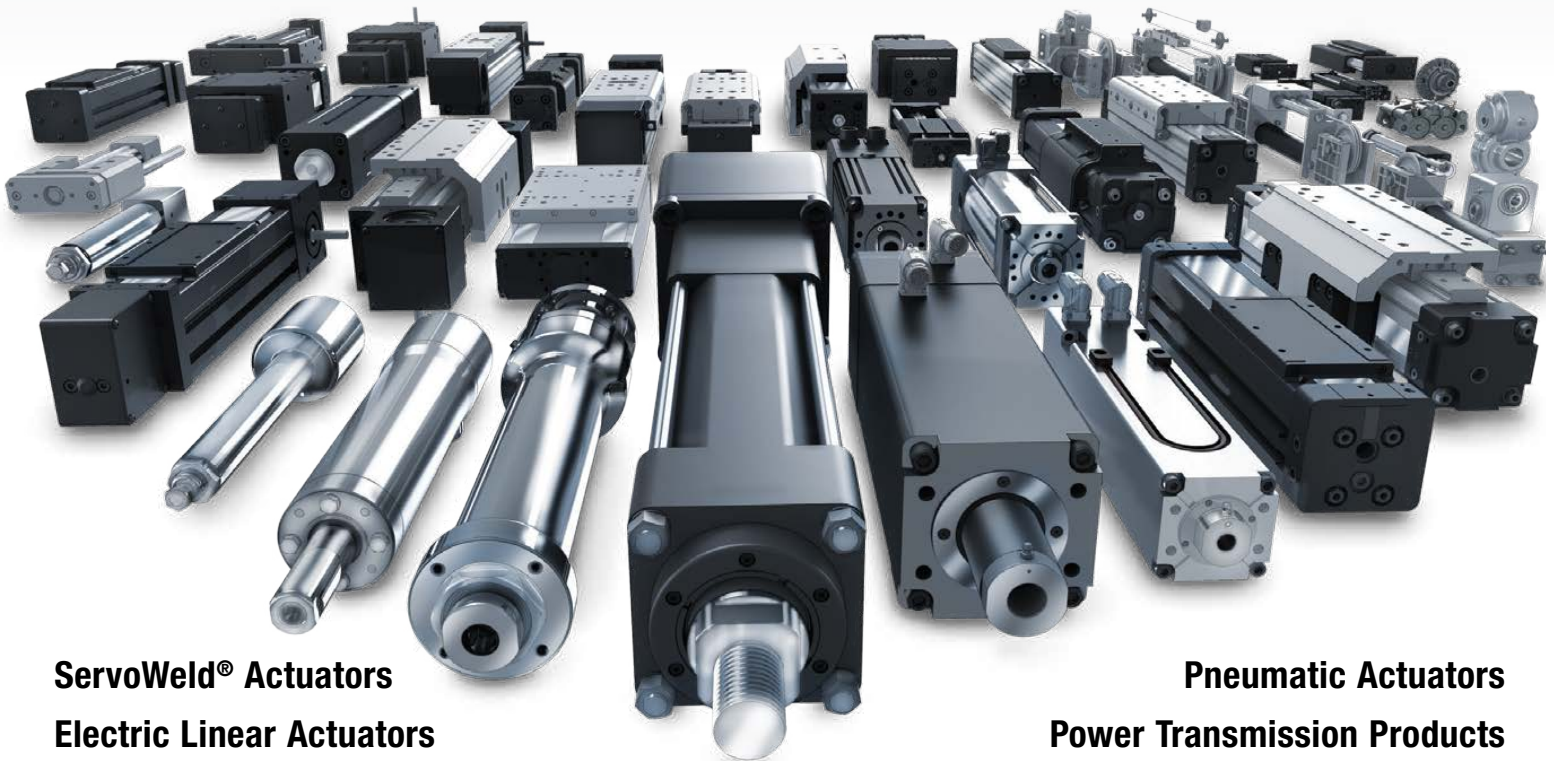

**ServoWeld<sup>®</sup> Actuators**  
**Electric Linear Actuators**

**Pneumatic Actuators**  
**Power Transmission Products**



MADE IN U.S.A.

# Tolomatic<sup>TM</sup>

EXCELLENCE IN MOTION

COMPANY WITH  
QUALITY SYSTEM  
CERTIFIED BY DNV  
= ISO 9001 =  
Certified site: Hamel, MN

### USA - Headquarters

#### Tolomatic Inc.

3800 County Road 116  
Hamel, MN 55340, USA  
**Phone:** (763) 478-8000  
Toll-Free: **1-800-328-2174**  
sales@tolomatic.com  
[www.tolomatic.com](http://www.tolomatic.com)

### MEXICO

#### Centro de Servicio

Parque Tecnológico Innovación  
Int. 23, Lateral Estatal 431,  
Santiago de Querétaro,  
El Marqués, México, C.P. 76246  
**Phone:** +1 (763) 478-8000  
help@tolomatic.com

### EUROPE

#### Tolomatic Europe GmbH

Elisabethenstr. 20  
65428 Rüsselsheim  
Germany  
**Phone:** +49 6142 17604-0  
help@tolomatic.eu  
[www.tolomatic.com/de-de](http://www.tolomatic.com/de-de)

### CHINA

#### Tolomatic Automation Products (Suzhou) Co. Ltd.

No. 60 Chuangye Street, Building 2  
Huqiu District, SND Suzhou  
Jiangsu 215011 - P.R. China  
**Phone:** +86 (512) 6750-8506  
Tolomatic\_China@tolomatic.com

All brand and product names are trademarks or registered trademarks of their respective owners. Information in this document is believed accurate at time of printing. However, Tolomatic assumes no responsibility for its use or for any errors

that may appear in this document. Tolomatic reserves the right to change the design or operation of the equipment described herein and any associated motion products without notice. Information in this document is subject to change without notice.

Visit [www.tolomatic.com](http://www.tolomatic.com) for the most up-to-date technical information