

# **MXE SCREW DRIVE ACTUATORS**

**ENDURANCE TECHNOLOGY**<sup>SM</sup>  
A Tolomatic Design Principle

**S** SOLID BEARING  
**P** PROFILED RAIL



**LINEAR SOLUTIONS MADE EASY**

# THE MXE ELECTRIC ACTUATOR – DESIGNED TO OUTLAST EVERY RODLESS ACTUATOR ON THE MARKET

The MXE electric actuator is exactly what you expect from the industry's number one rodless supplier. Designed with our exclusive **ENDURANCE TECHNOLOGY**<sup>SM</sup> features, the MX delivers superior performance to meet the most demanding applications. Nobody knows rodless like Tolomatic, and the MX proves it.

- **DURABLE BEARINGS.** Two bearing choices to match your application needs. Solid bearing design optimizes stress distribution for optimal performance. Profiled rail design uses recirculating ball technology to reduce friction and extend actuator life.
- **DURABLE BANDS.** Stainless steel bands are stronger and will not elongate like elastomer (non-metallic) bands, providing a reliable seal over the life of the actuator.



## **S**-SOLID BEARING

- Large bearing surface contact area optimizes stress distribution on bearing for long service life
- Large carrier mounting pattern for more load stability and compatibility with existing BCS applications
- Engineered bearing material does not require additional lubrication
- Solid bearings are field replaceable

## **P**-PROFILED RAIL

- Recirculating ball bearings with reduced friction for reliable service life
- High load and bending moment capacities
- Low profile to fit your application
- High precision bearings feature smooth, low breakaway motion

**Our broad line of MX products includes electric actuators (belt-drive & screw-drive) and pneumatic rodless cylinders.**

**World class product performance, fifteen days built-to-order and legendary customer service . . . what you expect from the leader . . . Tolomatic!**

# SELECT THE PERFORMANCE YOU NEED

Choose from: • Two Bearing Models • Six Actuator Sizes • Built to Your Specified Stroke Length

## MOMENT & LOAD CAPACITY COMPARISON

Graph for model comparison, data from MXE40 actuator

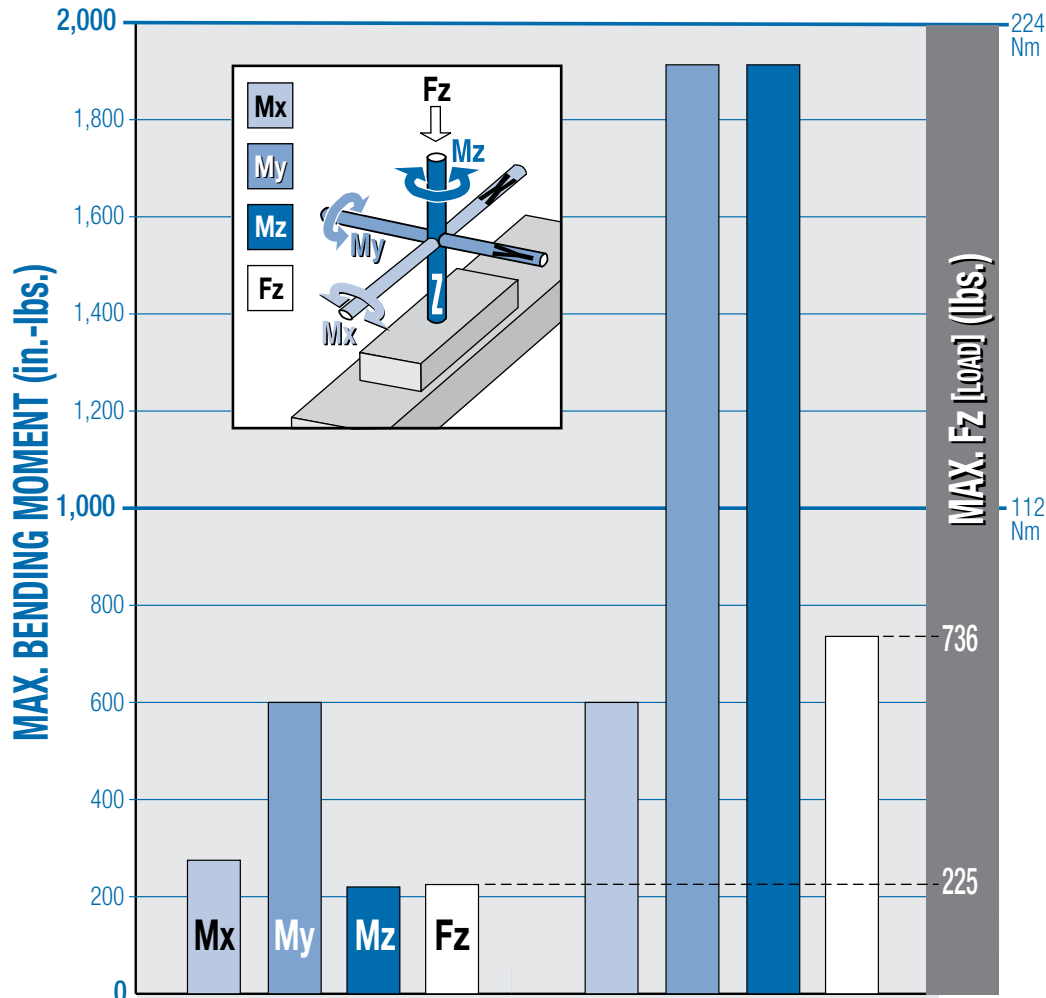

**Tolomatic MX Electric Actuator Model**



Bearing Type	Moment Capacity	Ideal Applications	Product Features
Solid Bearing	Moderate + Mx Capacity	<ul style="list-style-type: none"> <li>• Side Loads</li> <li>• Moderate or Light Loads</li> <li>• Guided Loads</li> </ul>	<b>Page MXE_4</b>
Profiled Rail	High	<ul style="list-style-type: none"> <li>• High Moment Loads</li> <li>• High Speeds with Heavy Loads</li> <li>• High Precision</li> </ul>	<b>Page MXE_6</b>

### CONTENTS

- Introduction .....2
- Comparison.....3
- S** Solid Bearing Features.....4
- P** Profiled Rail Features.....6
- S** Moment and Load Capacity .....8
- P** Moment and Load Capacity .....10
- Specifications .....13
- Tube Clamp Requirements .....16
- Screw Critical Speed Capacities.....17
- S** Solid Bearing Dimensions.....21
- P** Profiled Rail Bearing Dimensions .....23
- S** Reverse Parallel Motor Mounting Dimensions.....25
- P** Reverse Parallel Motor Mounting Dimensions.....27
- Switches .....29
- Application Data Worksheet .....31
- Selection Guidelines .....32
- S** Adjustment Procedures .....33
- Service Parts .....34
- Ordering .....35

# MXE-S SOLID BEARING SCREW ACTUATOR

## ENDURANCE TECHNOLOGY<sup>SM</sup>

A Tolomatic Design Principle

Endurance Technology features are designed for maximum durability to provide extended service life.

The MXE-S rodless electric screw-drive actuator is designed for applications requiring moderate load carrying and guidance. The MXE-S actuator utilizes two field replaceable solid bearings that optimize stress distribution for optimal performance. Built-to-order in stroke lengths up to 4.5m (178").

### LIGHTWEIGHT ALUMINUM DESIGN

Clear anodized extrusion design is optimized for rigidity and strength

### STAINLESS STEEL BAND

Exterior dust band made of fatigue resistant, durable, flexible and corrosion resistant stainless steel

### RETAINED DUST BAND

Retained dust band keeps contaminants from entering the actuator interior, protecting components for reduced maintenance and increased uptime

### NON-WEAR BAND RETENTION

- Magnetically retained band is not subject to wear as are mechanically retained systems
- Immediate band engagement and release results in less drag on carrier for lower friction force during initial carrier movement

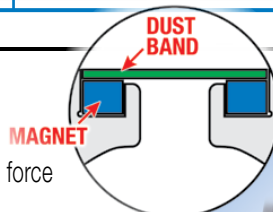

### LARGE FLEXIBLE MOUNTING PATTERN

- Carrier gives more load stability
- Compatibility with existing BCS applications
- More fastening options

### DUST WIPER

- Formed end cap and side dust wipers keep contaminants from entering the actuator's internal area

### MULTIPLE SCREW TECHNOLOGIES

#### YOU CAN CHOOSE:

- Solid nuts of engineered resins for quiet performance at the lowest cost - 5 choices
- Ball nuts offer positioning accuracy and repeatability with longer life, low-backlash available - 3 choices



## INCH OR METRIC MOUNTING

Your choice of inch (*US standard*) or metric mounting to the carrier

## YOUR MOTOR HERE

### YOU CAN CHOOSE:

- Motor or gearbox supplied and installed by Tolomatic
- Specify the device to be installed and actuator ships with proper mounting hardware - MXE is a "Your Motor Here" actuator for easy in-line motor installation. Check our website ([www.tolomatic.com/ymh](http://www.tolomatic.com/ymh)) for complete YMH information
- Specify and ship your device to Tolomatic for factory installation

## MOTOR ORIENTATION

### YOU CAN CHOOSE:

- Inline option directly couples the driving shafts and is a one-piece housing construction for optimum alignment and support of the motor
- Reverse-parallel option minimizes the overall length and offers a 1:1 or 2:1 belt ratio

## NON-BINDING BEARING ARMS

Bearings are tensioned indirectly, providing bind free adjustment

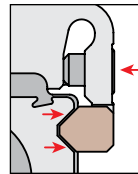

## TRAPEZOIDAL BEARINGS

- Trapezoidal design maximizes bearing surface area for less pressure on bearing surfaces; less pressure results in less wear
- Engineered bearing material has low static and dynamic friction with low wear properties for long lasting, smooth operation
- Bearings are field replaceable for extended service life

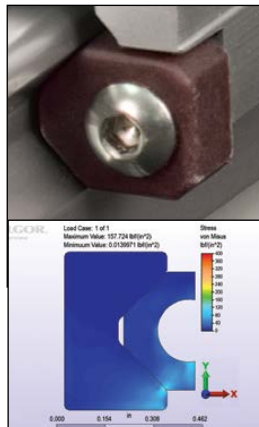

NOTE: Boxed letters indicate ordering codes

## INTERNAL MAGNETS

Standard feature that allows sensor installation on the open side or bottom of the extrusion

## OPTIONS



### AUXILIARY CARRIER **D****C**

- 2X higher Fz (load) capacity
- High bending moment capacity



### FLOATING MOUNT **F****L**

- Compensates for non-parallelism between MX actuator and externally guided load



### TUBE CLAMPS **T****C**

- Used for intermediate support
- Flush with bottom of actuator to retain low profile
- Drop-in, adjustable mounting locations (MXE16 uses T-nuts with mounting plates)



### MOUNTING PLATES **M****P**

- To provide clearance for motor and mount
- Use in conjunction with tube clamps



### SWITCHES

- Wide variety of sensing choices: Reed, Solid State PNP or NPN, all available normally open or normally closed
- Flush mount, drop-in installation
- Bright LEDs, power & signal indication
- CE rated, RoHS compliant

# MXE-**P** SOLID BEARING SCREW ACTUATOR

## **ENDURANCE TECHNOLOGY**<sup>SM</sup>

A Tolomatic Design Principle

*Endurance Technology features are designed for maximum durability to provide extended service life.*

The MXE-P rodless electric screw-drive actuator is designed for applications requiring moderate to heavy load carrying and guidance. The MXE-P actuator features a profiled rail system with recirculating ball linear guides for optimal performance. Built-to-order in stroke lengths up to 4.5m (178").

### **INTERNAL MAGNETS**

Standard feature that allows sensor installation on the open side or bottom of the extrusion

### **DUST WIPER**

Formed end cap and side dust wipers keep contaminants from entering the actuator's internal area

### **STAINLESS STEEL BAND**

Exterior dust band made of fatigue resistant, durable, flexible and corrosion resistant stainless steel

### **RECIRCULATING BALL BEARINGS**

- Recirculating ball bearings are used to reduce friction and extend actuator life
- Designed with a grease pocket between ball elements to reduce friction, noise and maintenance
- Large permissible moment loads
- High speed operation, low heat generation
- High precision, smooth, low friction motion

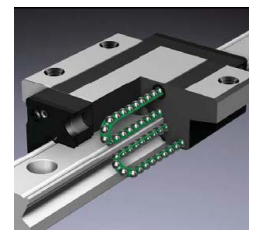

Grease pocket

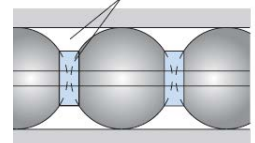

### **LIGHTWEIGHT ALUMINUM DESIGN**

Clear anodized extrusion design is optimized for rigidity and strength

### **INCH OR METRIC MOUNTING**

Your choice of inch (*US standard*) or metric mounting to the carrier

# Tolomatic... MAXIMUM DURABILITY

EXCELLENCE IN MOTION

## LOW CARRIER HEIGHT

- Reduces overall actuator envelope
- Large mounting pattern for excellent load stability

## YOUR MOTOR HERE

### YOU CAN CHOOSE:

- Motor or gearbox supplied and installed by Tolomatic
- Specify the device to be installed and actuator ships with proper mounting hardware - MXE is a "Your Motor Here" actuator for easy in-line motor installation. Check our website ([www.tolomatic.com/ymh](http://www.tolomatic.com/ymh)) for complete YMH information
- Specify and ship your device to Tolomatic for factory installation

## MOTOR ORIENTATION

### YOU CAN CHOOSE:

- In-line option directly couples the driving shafts and is a one-piece housing construction for optimum alignment and support of the motor
- Reverse-parallel option minimizes the overall length and offers a 1:1 or 2:1 belt ratio

## NON-WEAR BAND RETENTION

- Magnetically retained band is not subject to wear as are mechanically retained systems
- Immediate band engagement and release results in less drag on carrier for lower friction force during initial carrier movement

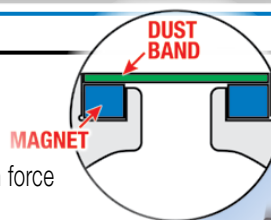

## RETAINED DUST BAND

Retained dust band keeps contaminants from entering the actuator interior, protecting components for reduced maintenance and increased uptime

## MULTIPLE SCREW TECHNOLOGIES

### YOU CAN CHOOSE:



- Solid nuts of engineered resins offer quiet performance at the lowest cost - 5 choices



- Ball nuts offer positioning accuracy and repeatability with longer life, low-backlash available - 3 choices

NOTE: Boxed letters indicate ordering codes

## OPTIONS



### AUXILIARY CARRIER **D****C**

- 2X higher Fz (load) capacity
- High bending moment capacity



### TUBE CLAMPS **T****C**

- Used for intermediate support
- Flush with bottom of actuator to retain low profile
- Drop-in, adjustable mounting locations (MXE16 uses T-nuts with Mounting Plates)



### MIRRORED CARRIER **B****I****R**

- Bracket in Reverse (Carrier) (Mirrored)



### MOUNTING PLATES **M****P**

- To provide clearance for motor and mount
- Use in conjunction with tube clamps



### SWITCHES

- Wide variety of sensing choices: Reed, Solid State PNP or NPN, all available normally open or normally closed
- Flush mount, drop-in installation
- Bright LEDs, power & signal indication
- CE rated, RoHS compliant

# S SOLID BEARING MOMENT AND LOAD CAPACITY

## STANDARD CARRIER

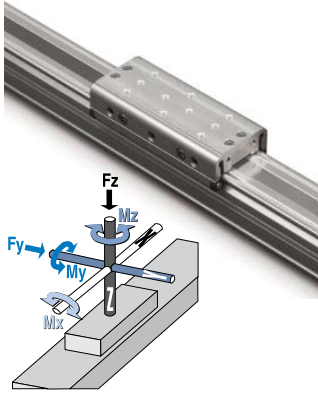

SIZE	MAXIMUM BENDING MOMENTS			MAX. LOAD
	Mx	My	Mz	Fz
	N-m	N-m	N-m	N
16	2.5	2.1	2.8	156
25	6.8	12.4	3.8	311
32	11.3	39.5	15.8	667
40	31.1	67.8	24.9	1,001
50	35.6	131	38.5	1,401
63	66.1	264	58.8	2,313

SIZE	MAXIMUM BENDING MOMENTS			MAX. LOAD
	Mx	My	Mz	Fz
	in-lbs	in-lbs	in-lbs	lbf
16	22	19	25	35
25	60	110	34	70
32	100	350	140	150
40	275	600	220	225
50	315	1,155	341	315
63	585	2,340	520	520

**⚠ The above ratings are the maximum values for shock-free, vibration-free operation in a typical industrial environment, which must not be exceeded even in dynamic operation. Contact Tolomatic for assistance in selecting the most appropriate actuator for your application.**



**sizeit.tolomatic.com for fast, accurate actuator selection** or call Tolomatic (1-800-328-2174) with application information. We will provide any assistance needed to determine the proper MXE screw-driven actuator.



**tolomatic.com/ask**  
Technical support before and after purchase

The moment and load capacity of the actuator's bearing system is based on an L10 life of 5,000,000 linear meters of travel. Life of the actuator will vary for each application depending on the combined loads, motion parameters and operating conditions. The load factor ( $L_F$ ) for each application must not exceed a value of 1 (as calculated below). Exceeding a load factor of 1 will diminish the actuator's rated life.

$$L_F = \frac{M_x}{M_{x_{max}}} + \frac{M_y}{M_{y_{max}}} + \frac{M_z}{M_{z_{max}}} + \frac{F_y}{F_{y_{max}}} + \frac{F_z}{F_{z_{max}}} \leq 1$$

With combined loads,  $L_F$  must not exceed the value 1.



# S SOLID BEARING MOMENT AND LOAD CAPACITY

## DC AUXILIARY CARRIER

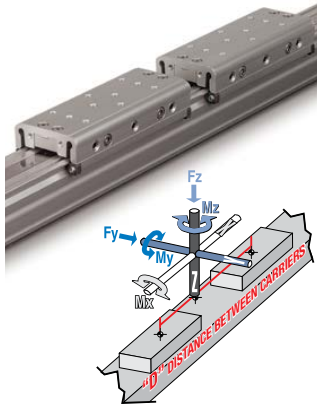

AUXILIARY CARRIER BENDING MOMENTS WITH INCREASED "D" DISTANCE BETWEEN CARRIERS

SIZE	"D" MIN.	MAXIMUM BENDING MOMENTS*			MAX. LOAD
		Mxa	Mya	Mza	
		N-m	N-m	N-m	
16	127	5.0	19.8	19.8	311
25	152	13.6	47.5	47.5	623
32	178	22.6	119	119	1,334
40	216	62.1	216	216	2,002
50	218	71.2	306	306	2,802
63	330	132	764	764	4,626

SIZE	"D" MIN.	MAXIMUM BENDING MOMENTS*			MAX. LOAD
		Mxa	Mya	Mza	
		in-lbs	in-lbs	in-lbs	
16	5.0	44	175	175	70
25	6.0	120	420	420	140
32	7.0	200	1,050	1,050	300
40	8.5	550	1,913	1,913	450
50	8.6	630	2,709	2,709	630
63	13.0	1,170	6,760	6,760	1,040

\*At minimum "D" distance see graph below for complete information

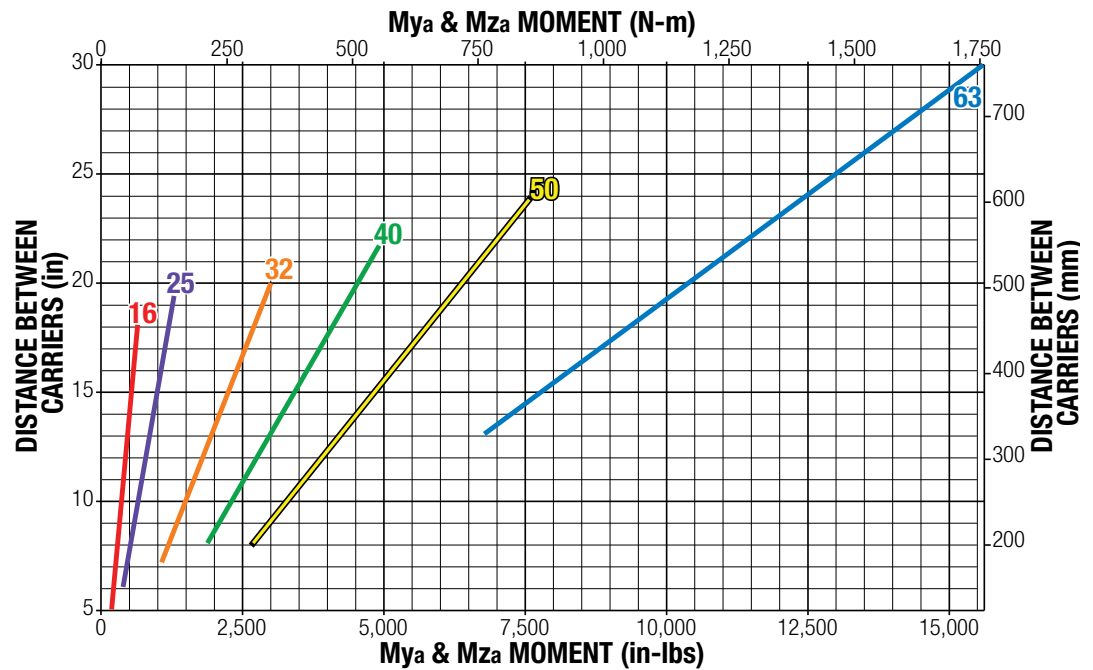

Ratings were calculated with the following conditions:

- 1.) Coupling between carriers is rigid.
- 2.) Load is equally distributed between carriers.
- 3.) Coupling device applies no misalignment loads to carriers.

**⚠** The above ratings are the maximum values for shock-free, vibration-free operation in a typical industrial environment, which must not be exceeded even in dynamic operation. Contact Tolomatic for assistance in selecting the most appropriate actuator for your application.

With combined loads,  $L_f$  must not exceed the value 1.

$$L_f = \frac{M_x}{M_{x_{max}}} + \frac{M_y}{M_{y_{max}}} + \frac{M_z}{M_{z_{max}}} + \frac{F_y}{F_{y_{max}}} + \frac{F_z}{F_{z_{max}}} \leq 1$$

[sizeit.tolomatic.com](http://sizeit.tolomatic.com) for fast, accurate actuator selection

[sizeit.tolomatic.com](http://sizeit.tolomatic.com) for fast, accurate actuator selection or call Tolomatic (1-800-328-2174) with application information. We will provide any assistance needed to determine the proper MXE screw-driven actuator.

[tolomatic.com/ask](http://tolomatic.com/ask) Technical support before and after purchase

# PROFILED RAIL MOMENT AND LOAD CAPACITY

⚠ Mating surface of mounted component must maintain a flatness of at least .0015" [0.040mm]

## STANDARD CARRIER

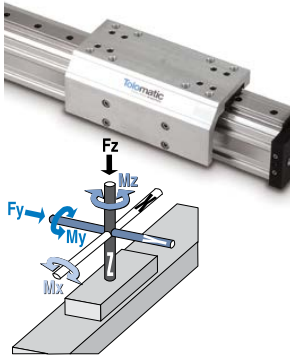

SIZE	MAXIMUM BENDING MOMENTS			MAXIMUM LOAD	
	Mx	My	Mz	Fy	Fz
	N-m	N-m	N-m	N	N
16	4.5	38.3	38.3	966	966
25	14.3	56.7	42.6	1,996	1,996
32	25.6	152	152	2,531	2,531
40	68.2	216	216	3,274	3,274
50	91.7	394	394	4,510	4,510
63	115	603	603	5,745	5,745

SIZE	MAXIMUM BENDING MOMENTS			MAXIMUM LOAD	
	Mx	My	Mz	Fy	Fz
	in-lbs	in-lbs	in-lbs	lbf	lbf
16	39	339	339	217	217
25	126	502	377	449	449
32	226	1,344	1,344	569	569
40	604	1,913	1,913	736	736
50	811	3,483	3,483	1,014	1,014
63	1,019	5,339	5,339	1,292	1,292

⚠ The above ratings are the maximum values for shock-free, vibration-free operation in a typical industrial environment, which must not be exceeded even in dynamic operation. Contact Tolomatic for assistance in selecting the most appropriate actuator for your application.

### SPEED FACTOR

FOR APPLICATIONS WITH HIGH SPEED OR SIGNIFICANT SHOCK AND VIBRATION: Calculated values of loads and bending moments must be increased by speed factor from the graph at right to obtain full rated life of profiled rail bearing system.

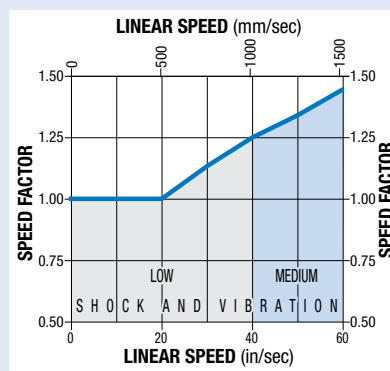

The moment and load capacity of the actuator's bearing system is based on an L10 life of 5,000,000 linear meters of travel. Life of the actuator will vary for each application depending on the combined loads, motion parameters and operating conditions. The load factor ( $L_f$ ) for each application must not exceed a value of 1 (as calculated below). Exceeding a load factor of 1 will diminish the actuator's rated life.

$$L_f = \frac{M_x}{M_{x_{max}}} + \frac{M_y}{M_{y_{max}}} + \frac{M_z}{M_{z_{max}}} + \frac{F_y}{F_{y_{max}}} + \frac{F_z}{F_{z_{max}}} \leq 1$$

With combined loads,  $L_f$  must not exceed the value 1.

### PROFILED RAIL LUBRICATION

Proper lubrication of profiled rail bearing system is essential for normal operation and achievement of full rated life of MXE-P actuators. Lubrication should be performed at intervals of 101,600 meters of travel or once every year, whichever occurs first. **However, operating conditions such as high speed or significant shock and vibration may require more frequent lubrication.** Please consult Tolomatic for recommendations.

#### Recommended grease types:

1. Refined mineral oil-based multi-purpose grease with lithium thickening agent.
2. High-grade synthetic oil-based grease with urea thickening agent.



[sizeit.tolomatic.com](http://sizeit.tolomatic.com) for fast, accurate actuator selection or call Tolomatic (1-800-328-2174) with application information. We will provide any assistance needed to determine the proper MXE screw-driven actuator.



# PROFILED RAIL MOMENT AND LOAD CAPACITY

⚠ Mating surface of mounted component must maintain a flatness of at least .0015" [0.040 mm]

## AUXILIARY CARRIER

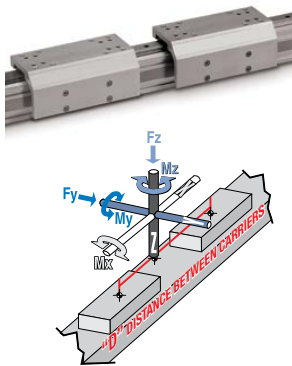

SIZE	"D" MIN.	MAXIMUM BENDING MOMENTS*			MAXIMUM LOAD	
		Mxa	Mya	Mza	Fya	Fza
		N-m	N-m	N-m	N	N
16	127	8.9	70.0	70.0	1,932	1,932
25	152	28.5	182	182	3,993	3,993
32	178	51.1	249	249	5,063	5,063
40	216	136	407	407	6,549	6,549
50	218	183	561	561	9,020	9,020
63	330	230	1,074	1,074	11,490	11,490

SIZE	"D" MIN.	MAXIMUM BENDING MOMENTS*			MAXIMUM LOAD	
		Mxa	Mya	Mza	Fya	Fza
		in-lbs	in-lbs	in-lbs	lbf	lbf
16	5.0	79	620	620	434	434
25	6.0	252	1,610	1,610	898	898
32	7.0	453	2,202	2,202	1,138	1,138
40	8.5	1,208	3,601	3,601	1,472	1,472
50	8.6	1,623	4,966	4,966	2,028	2,028
63	13.0	2,038	9,508	9,508	2,583	2,583

\*At minimum "D" distance see below for complete information

## AUXILIARY CARRIER BENDING MOMENTS WITH INCREASED "D" DISTANCE BETWEEN CARRIERS

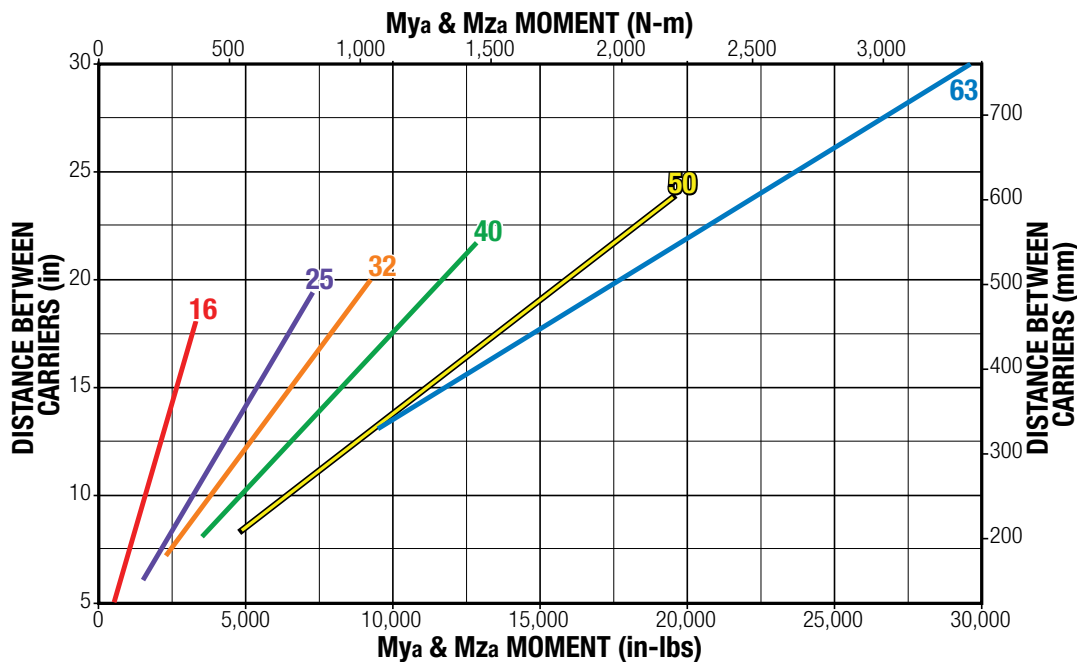

### Ratings were calculated with the following conditions:

- 1.) Coupling between carriers is rigid.
- 2.) Load is equally distributed between carriers.
- 3.) Coupling device applies no misalignment loads to carriers.

⚠ The above ratings are the maximum values for shock-free, vibration-free operation in a typical industrial environment, which must not be exceeded even in dynamic operation. Contact Tolomatic for assistance in selecting the most appropriate actuator for your application.

With combined loads,  $L_F$  must not exceed the value 1.

$$L_F = \frac{M_x}{M_{x_{max}}} + \frac{M_y}{M_{y_{max}}} + \frac{M_z}{M_{z_{max}}} + \frac{F_y}{F_{y_{max}}} + \frac{F_z}{F_{z_{max}}} \leq 1$$

[sizeit.tolomatic.com](http://sizeit.tolomatic.com) for fast, accurate actuator selection

[sizeit.tolomatic.com](http://sizeit.tolomatic.com) for fast, accurate actuator selection or call Tolomatic (1-800-328-2174) with application information. We will provide any assistance needed to determine the proper MXE screw-driven actuator.

[tolomatic.com/ask](mailto:tolomatic.com/ask) Technical support before and after purchase

# LOAD DEFLECTION

## DEFLECTION ABOUT X AXIS

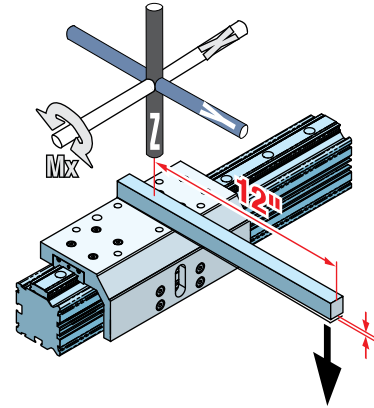
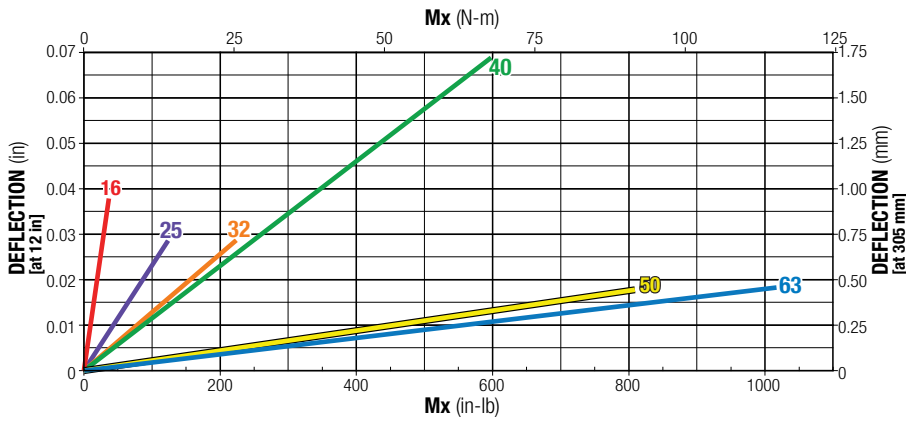

## DEFLECTION ABOUT Y AXIS

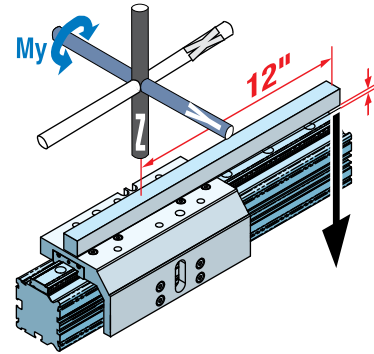
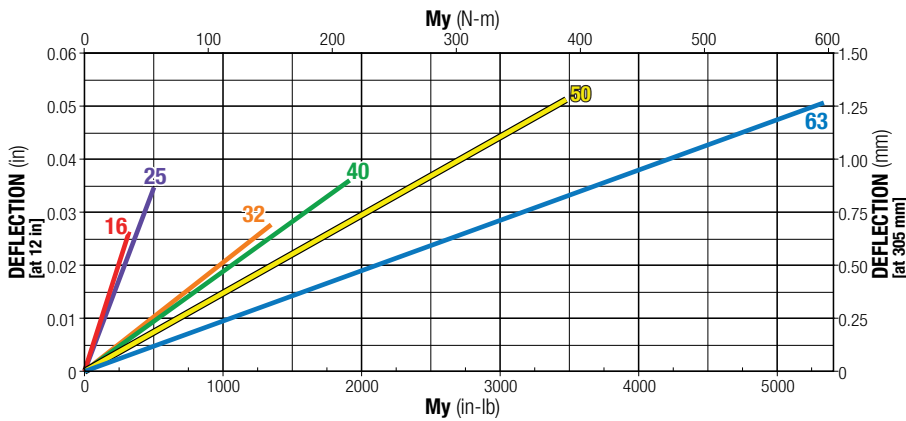

## DEFLECTION ABOUT Z AXIS

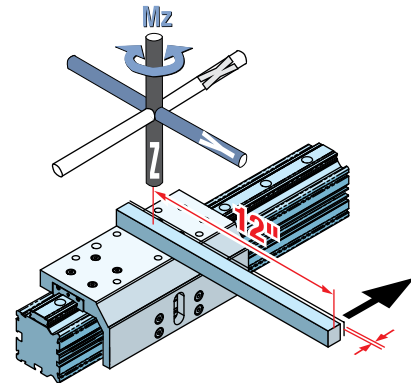
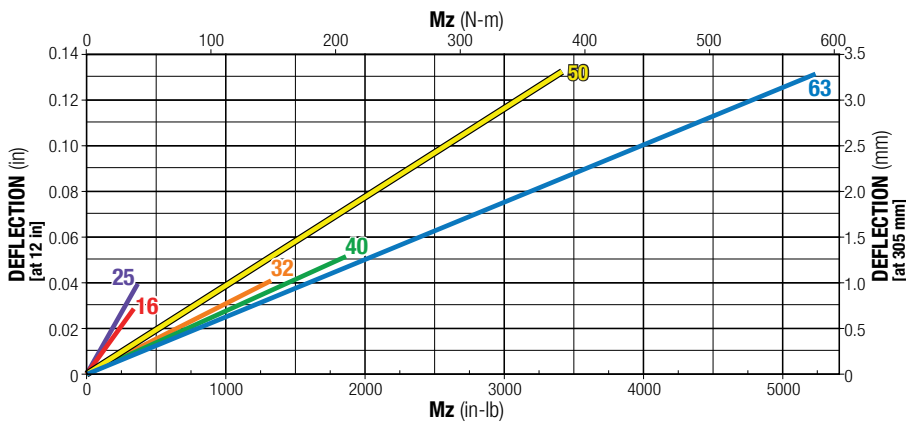

sizeit.tolomatic.com for fast, accurate actuator selection



tolomatic.com/ask Technical support before and after purchase

### DEFLECTION TESTING WAS DONE UNDER THESE CRITERIA:

- 1.) Actuator was properly mounted with distance between mounting plates within recommendations (see Tube Clamp Requirements page MXE\_16)
- 2.) Deflection was measured at 12" from center of carrier as shown

# S & P ACTUATOR SPECIFICATIONS AND BREAKAWAY TORQUE

## GENERAL ACTUATOR SPECIFICATIONS

SIZE	WEIGHT						STRAIGHT-NESS / FLATNESS***	TEMP. RANGE
	CARRIER*		BASE ACTUATOR**		PER mm OF STROKE			
	S	P	S	P	S	P		
	kg	kg	kg	kg	kg/mm	kg/mm	mm	°C
16	0.21	0.26	0.56	0.65	0.0018	0.0021	.0170 x L†	4 to 54
25	0.41	0.46	0.96	1.11	0.0034	0.0045		
32	0.79	0.96	1.24	1.50	0.0052	0.0066		
40	1.43	1.69	2.42	3.12	0.0071	0.0104		
50	2.39	3.16	6.76	8.29	0.0114	0.0150		
63	5.88	6.77	15.90	17.84	0.0193	0.0243		

SIZE	WEIGHT						STRAIGHT-NESS / FLATNESS***	TEMP. RANGE
	CARRIER*		BASE ACTUATOR**		PER in OF STROKE			
	S	P	S	P	S	P		
	lb	lb	lb	lb	lb/in	lb/in	in	°F
16	0.47	0.58	1.24	1.43	0.10	0.12	.00067 x L†	40 to 130
25	0.91	1.02	2.11	2.44	0.19	0.25		
32	1.74	2.12	2.74	3.30	0.29	0.37		
40	3.15	3.72	5.34	6.88	0.40	0.58		
50	5.27	6.97	14.91	18.27	0.64	0.84		
63	12.96	14.92	35.05	39.34	1.08	1.36		

S = Solid Bearing, P = Profiled Rail Bearing \*\*\*Actuator mounted on a flat surface and fully restrained (See tube clamp graphs page MXE\_16)  
 \*including nut bracket assembly  
 \*\*Excluding nut bracket and carrier assembly † L = Maximum distance between tube clamps

IP Rating - 44 Approximately equivalent to the requirements of IP44 (protected against ingress of solid particles greater than .039 in (1 mm) and splashing water)

## FRICITION FORCE S-ACTUATORS

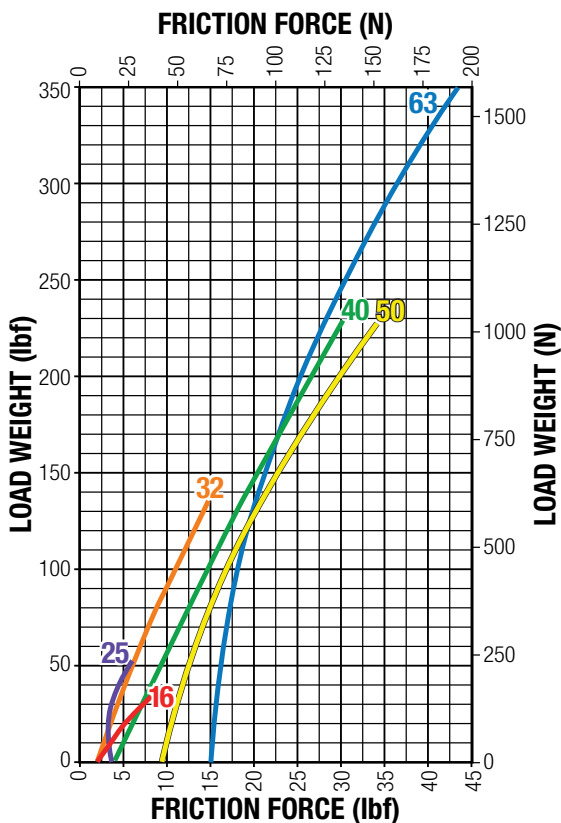

## BREAKAWAY TORQUE

ACTUATOR SERIES	SCREW DIAMETER	SCREW ORDERING DESCRIPTION	BREAKAWAY TORQUE	
			SINGLE CARRIER	AUXILIARY CARRIER
			N-m	N-m
MXE16	6.35	SN02	0.071	0.099
	6.35	SN04	0.071	0.099
	6.35	SN16	0.071	0.099
MXE25	9.53	BN08	0.113	0.127
	9.53	BNL08	0.113	0.127
	10.00	BNM10	0.113	0.127
	12.70	SN01	0.212	0.325
	12.70	SN02	0.177	0.247
	12.70	SN05	0.127	0.155
MXE32	9.53	BN08	0.113	0.127
	9.53	BNL08	0.113	0.127
	10.00	BNM10	0.113	0.127
	12.70	SN01	0.212	0.325
	12.70	SN02	0.177	0.247
	12.70	SN05	0.127	0.155
MXE40	12.70	BN02	0.198	0.247
	12.70	BNL02	0.198	0.247
	15.88	BN05	0.247	0.318
	15.88	BNL05	0.247	0.318
	15.88	SN02	0.245	0.311
	19.05	SN01	0.353	0.508
MXE50	19.05	BN02	0.282	0.353
	19.05	BNL02	0.282	0.353
	19.05	BN05	0.247	0.318
	19.05	BNL05	0.247	0.318
	25.40	BN01	0.530	0.756
MXE63	25.40	BNL01	0.530	0.756
	25.40	BN02	0.530	0.756
	25.40	BNL02	0.530	0.756
	25.40	BN04	0.600	0.855
	25.40	BNL04	0.600	0.855
	25.40	BNL04	0.600	0.855

ACTUATOR SERIES	SCREW DIAMETER	SCREW ORDERING DESCRIPTION	BREAKAWAY TORQUE	
			SINGLE CARRIER	AUXILIARY CARRIER
			oz-in	oz-in
MXE16	0.250	SN02	10	14
	0.250	SN04	10	14
	0.250	SN16	10	14
MXE25	0.375	BN08	16	18
	0.375	BNL08	16	18
	0.394	BNM10	16	18
	0.500	SN01	30	46
	0.500	SN02	25	35
	0.500	SN05	18	22
MXE32	0.375	BN08	16	18
	0.375	BNL08	16	18
	0.500	BNM10	30	46
	0.394	SN01	16	18
	0.500	SN02	25	35
	0.500	SN05	18	22
MXE40	0.500	BN02	28	35
	0.500	BNL02	28	35
	0.625	BN05	35	45
	0.625	BNL05	35	45
	0.625	SN02	35	44
	0.750	SN01	50	72
MXE50	0.750	BN02	40	50
	0.750	BNL02	40	50
	0.750	BN05	35	45
	0.750	BNL05	35	45
	1.000	BN01	75	107
MXE63	1.000	BNL01	75	107
	1.000	BN02	75	107
	1.000	BNL02	75	107
	1.000	BN04	85	121
	1.000	BNL04	85	121



## SCREW SPECIFICATIONS

ACTUATOR SERIES	SCREW DIAMETER	SCREW ORDERING DESCRIPTION	SCREW LEAD	LEAD ACCURACY	BACKLASH	MAX THRUST	MAX STROKE
	mm		mm	mm/300mm			
MXE16	6.35	SN02	12.70	0.13	0.38	200	787.4
	6.35	SN04	6.35	0.13	0.38	200	787.4
	6.35	SN16	1.59	0.13	0.38	200	787.4
MXE25	9.53	BN08	3.18	0.10	0.38	578	1582.4
	9.53	BNL08	3.18	0.10	0.05	578	1582.4
	10.00	BNM10	10.00	0.10	0.06	1832	1582.4
	12.70	SN01	25.40	0.15	0.18	756	2496.8
	12.70	SN02	12.70	0.13	0.18	756	3411.2
	12.70	SN05	5.08	0.15	0.18	756	3411.2
MXE32	9.53	BN08	3.18	0.10	0.38	578	1572.3
	9.53	BNL08	3.18	0.10	0.05	578	1572.3
	10.00	BNM10	10.00	0.10	0.06	1832	1572.3
	12.70	SN01	25.40	0.15	0.18	756	2486.7
	12.70	SN02	12.70	0.13	0.18	756	3401.1
	12.70	SN05	5.08	0.15	0.18	756	3401.1
MXE40	12.70	BN02	12.70	0.08	0.38	3559	1521.5
	12.70	BNL02	12.70	0.08	0.05	3559	1521.5
	15.88	BN05	5.08	0.08	0.38	3559	1521.5
	15.88	BNL05	5.08	0.08	0.05	3559	1521.5
	15.88	SN02	12.70	0.13	0.18	890	3350.3
	19.05	SN01	25.40	0.13	0.18	1334	3350.3
MXE50	19.05	BN02	12.70	0.10	0.38	12010	4539.0
	19.05	BNL02	12.70	0.10	0.05	12010	4539.0
	19.05	BN05	5.08	0.08	0.38	4226	3319.8
	19.05	BNL05	5.08	0.08	0.05	4226	3319.8
MXE63	25.40	BN01	25.40	0.10	0.38	11121	3185.2
	25.40	BNL01	25.40	0.10	0.05	11121	3185.2
	25.40	BN02	12.70	0.10	0.38	19127	3185.2
	25.40	BNL02	12.70	0.10	0.05	19127	3185.2
	25.40	BN04	6.35	0.10	0.38	14679	3185.2
	25.40	BNL04	6.35	0.10	0.05	14679	3185.2

ACTUATOR SERIES	SCREW DIAMETER	SCREW ORDERING DESCRIPTION	SCREW PITCH	SCREW LEAD	LEAD ACCURACY	BACKLASH	MAX THRUST	MAX STROKE
	in		rev/in	in	in/ft			
MXE16	0.250	SN02	2.00	0.50	0.005	0.015	45	31.0
	0.250	SN04	4.00	0.25	0.005	0.015	45	31.0
	0.250	SN16	16.00	0.06	0.005	0.015	45	31.0
MXE25	0.375	BN08	8.00	0.13	0.004	0.015	130	62.3
	0.375	BNL08	8.00	0.13	0.004	0.002	130	62.3
	0.394	BNM10	2.54	0.39	0.004	0.003	412	62.3
	0.500	SN01	1.00	1.00	0.006	0.007	170	98.3
	0.500	SN02	2.00	0.50	0.005	0.007	170	134.3
	0.500	SN05	5.00	0.20	0.006	0.007	170	134.3
MXE32	0.375	BN08	8.00	0.13	0.004	0.015	130	61.9
	0.375	BNL08	8.00	0.13	0.004	0.002	130	61.9
	0.394	BNM10	2.54	0.39	0.004	0.003	412	61.9
	0.500	SN01	1.00	1.00	0.006	0.007	170	97.9
	0.500	SN02	2.00	0.50	0.005	0.007	170	133.9
	0.500	SN05	5.00	0.20	0.006	0.007	170	133.9
MXE40	0.500	BN02	2.00	0.50	0.003	0.015	800	59.9
	0.500	BNL02	2.00	0.50	0.003	0.002	800	59.9
	0.625	BN05	5.00	0.20	0.003	0.015	800	59.9
	0.625	BNL05	5.00	0.20	0.003	0.002	800	59.9
	0.625	SN02	2.00	0.50	0.005	0.007	200	131.9
	0.750	SN01	1.00	1.00	0.005	0.007	300	131.9
MXE50	0.750	BN02	2.00	0.50	0.004	0.015	2700	178.7
	0.750	BNL02	2.00	0.50	0.004	0.002	2700	178.7
	0.750	BN05	5.00	0.20	0.003	0.015	950	130.7
	0.750	BNL05	5.00	0.20	0.003	0.002	950	130.7
MXE63	1.000	BN01	1.00	1.00	0.004	0.015	2500	125.4
	1.000	BNL01	1.00	1.00	0.004	0.002	2500	125.4
	1.000	BN02	2.00	0.50	0.004	0.015	4300	125.4
	1.000	BNL02	2.00	0.50	0.004	0.002	4300	125.4
	1.000	BN04	4.00	0.25	0.004	0.015	3300	125.4
	1.000	BNL04	4.00	0.25	0.004	0.002	3300	125.4



[sizeit.tolomatic.com](http://sizeit.tolomatic.com) for fast, accurate actuator selection

[sizeit.tolomatic.com](http://sizeit.tolomatic.com) for fast, accurate actuator selection or call Tolomatic (1-800-328-2174) with application information. We will provide any assistance needed to determine the proper MXE screw-driven actuator.



[tolomatic.com/ask](http://tolomatic.com/ask) Technical support before and after purchase

## REFLECTED INERTIA

ACTUATOR SERIES	SCREW DIAMETER	SCREW ORDERING DESCRIPTION	REFLECTED INERTIA				
			BASE ACTUATOR				PER 25mm OF STROKE
			S SOLID		P PROFILED RAIL		
			IN-LINE	REV PARALLEL	IN-LINE	REV PARALLEL	
mm		kg-cm <sup>2</sup>	kg-cm <sup>2</sup>	kg-cm <sup>2</sup>	kg-cm <sup>2</sup>	kg-cm <sup>2</sup>	
MXE16	6.35	SN02	0.0170	0.0170	0.0202	0.0202	0.0003
	6.35	SN04	0.0059	0.0059	0.0067	0.0067	0.0003
	6.35	SN16	0.0026	0.0026	0.0026	0.0026	0.0003
MXE25	9.53	BN08	0.0182	0.0182	0.0183	0.0183	0.0015
	9.53	BNL08	0.0182	0.0182	0.0183	0.0183	0.0015
	10.00	BNM10	0.0182	0.0182	0.0183	0.0183	0.0015
	12.70	SN01	0.1456	0.1456	0.1583	0.1583	0.0050
	12.70	SN02	0.0623	0.0623	0.0654	0.0654	0.0050
	12.70	SN05	0.0390	0.0390	0.0395	0.0395	0.0050
MXE32	9.53	BN08	0.0193	0.0193	0.0198	0.0198	0.0015
	9.53	BNL08	0.0193	0.0193	0.0198	0.0198	0.0015
	10.00	BNM10	0.0182	0.0182	0.0183	0.0183	0.0015
	12.70	SN01	0.2436	0.2465	0.2940	0.2969	0.0050
	12.70	SN02	0.0868	0.0897	0.0994	0.1023	0.0050
	12.70	SN05	0.0429	0.0458	0.0449	0.0478	0.0050
MXE40	12.70	BN02	0.1468	0.1470	0.1593	0.1594	0.0050
	12.70	BNL02	0.1480	0.1497	0.1593	0.1594	0.0050
	15.88	BN05	0.1480	0.1497	0.1500	0.1517	0.0123
	15.88	BNL05	0.1480	0.1497	0.1500	0.1517	0.0123
	15.88	SN02	0.2286	0.2304	0.2463	0.2480	0.0123
	19.05	SN01	0.5956	0.5973	0.6661	0.6679	0.0255
MXE50	19.05	BN02	0.4208	0.4246	0.4580	0.4618	0.0255
	19.05	BNL02	0.4208	0.4246	0.4580	0.4618	0.0255
	19.05	BN05	0.3231	0.3269	0.3289	0.3327	0.0255
	19.05	BNL05	0.3231	0.3269	0.3289	0.3327	0.0255
	25.40	BN01	2.5943	2.5966	2.7688	2.7711	0.0805
MXE63	25.40	BNL01	2.5943	2.5966	2.7688	2.7711	0.0805
	25.40	BN02	1.7459	1.7482	1.7889	1.7813	0.0805
	25.40	BNL02	1.7459	1.7482	1.7889	1.7813	0.0805
	25.40	BN04	1.5349	1.5372	1.5450	1.5473	0.0805
	25.40	BNL04	1.5349	1.5372	1.5450	1.5473	0.0805

ACTUATOR SERIES	SCREW DIAMETER	SCREW ORDERING DESCRIPTION	SCREW PITCH	REFLECTED INERTIA				
				BASE ACTUATOR				PER IN OF STROKE
				S SOLID		P PROFILED RAIL		
				IN-LINE	REV PARALLEL	IN-LINE	REV PARALLEL	
in		rev/in	lb-in <sup>2</sup>	lb-in <sup>2</sup>	lb-in <sup>2</sup>	lb-in <sup>2</sup>	lb-in <sup>2</sup>	
MXE16	0.250	SN02	2.00	0.0058	0.0058	0.0069	0.0069	0.0001
	0.250	SN04	4.00	0.0020	0.0020	0.0023	0.0023	0.0001
	0.250	SN16	16.00	0.0009	0.0009	0.0009	0.0009	0.0001
MXE25	0.375	BN08	8.00	0.0062	0.0062	0.0063	0.0063	0.0005
	0.375	BNL08	8.00	0.0062	0.0062	0.0063	0.0063	0.0005
	0.394	BNM10	2.54	0.0062	0.0062	0.0063	0.0063	0.0005
	0.500	SN01	1.00	0.0498	0.0498	0.0541	0.0541	0.0017
	0.500	SN02	2.00	0.0213	0.0213	0.0224	0.0224	0.0017
	0.500	SN05	5.00	0.0133	0.0133	0.0135	0.0135	0.0017
MXE32	0.375	BN08	8.00	0.0066	0.0066	0.0068	0.0068	0.0005
	0.375	BNL08	8.00	0.0066	0.0066	0.0068	0.0068	0.0005
	0.500	BNM10	2.54	0.0832	0.0842	0.1005	0.1015	0.0017
	0.394	SN01	1.00	0.0062	0.0062	0.0063	0.0063	0.0005
	0.500	SN02	2.00	0.0296	0.0306	0.0340	0.0350	0.0017
	0.500	SN05	5.00	0.0147	0.0157	0.0153	0.0163	0.0017
MXE40	0.500	BN02	2.00	0.0502	0.0502	0.0544	0.0545	0.0017
	0.500	BNL02	2.00	0.0502	0.0512	0.0544	0.0545	0.0017
	0.625	BN05	5.00	0.0506	0.0512	0.0512	0.0518	0.0042
	0.625	BNL05	5.00	0.0506	0.0512	0.0512	0.0518	0.0042
	0.625	SN02	2.00	0.0781	0.0787	0.0842	0.0848	0.0042
	0.750	SN01	1.00	0.2035	0.2041	0.2276	0.2282	0.0087
MXE50	0.750	BN02	2.00	0.1438	0.1451	0.1565	0.1578	0.0087
	0.750	BNL02	2.00	0.1438	0.1451	0.1565	0.1578	0.0087
	0.750	BN05	5.00	0.1104	0.1117	0.1124	0.1137	0.0087
	0.750	BNL05	5.00	0.1104	0.1117	0.1124	0.1137	0.0087
	1.000	BN01	1.00	0.8865	0.8873	0.9466	0.9474	0.0275
MXE63	1.000	BNL01	1.00	0.8865	0.8873	0.9466	0.9474	0.0275
	1.000	BN02	2.00	0.5966	0.5974	0.6116	0.6124	0.0275
	1.000	BNL02	2.00	0.5966	0.5974	0.6116	0.6124	0.0275
	1.000	BN04	4.00	0.5245	0.5253	0.5282	0.5290	0.0275
	1.000	BNL04	4.00	0.5245	0.5253	0.5282	0.5290	0.0275



# S & P TUBE CLAMP REQUIREMENTS



sizeit.tolomatic.com for fast, accurate actuator selection

## S SOLID BEARING

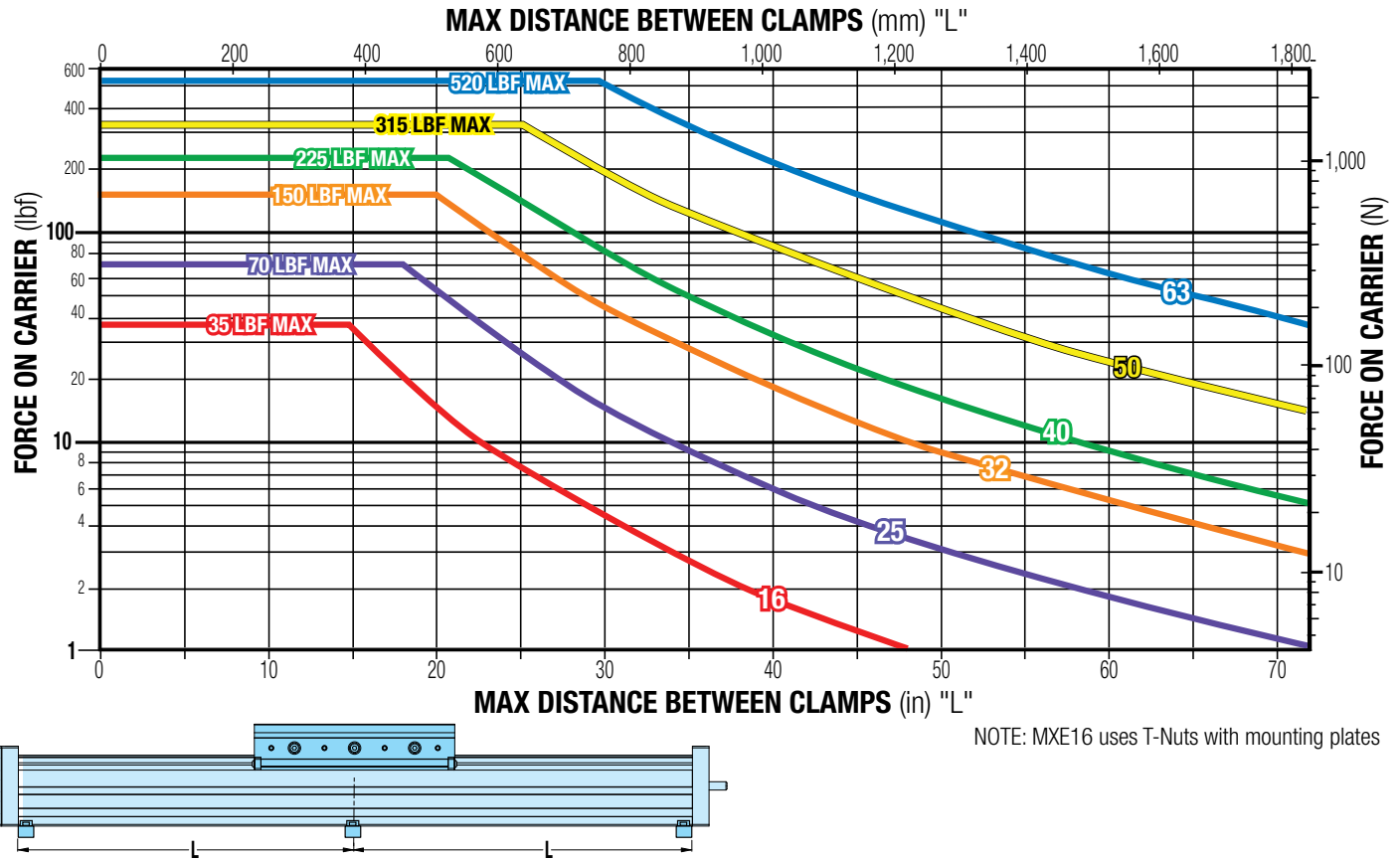

## P PROFILED RAIL BEARING

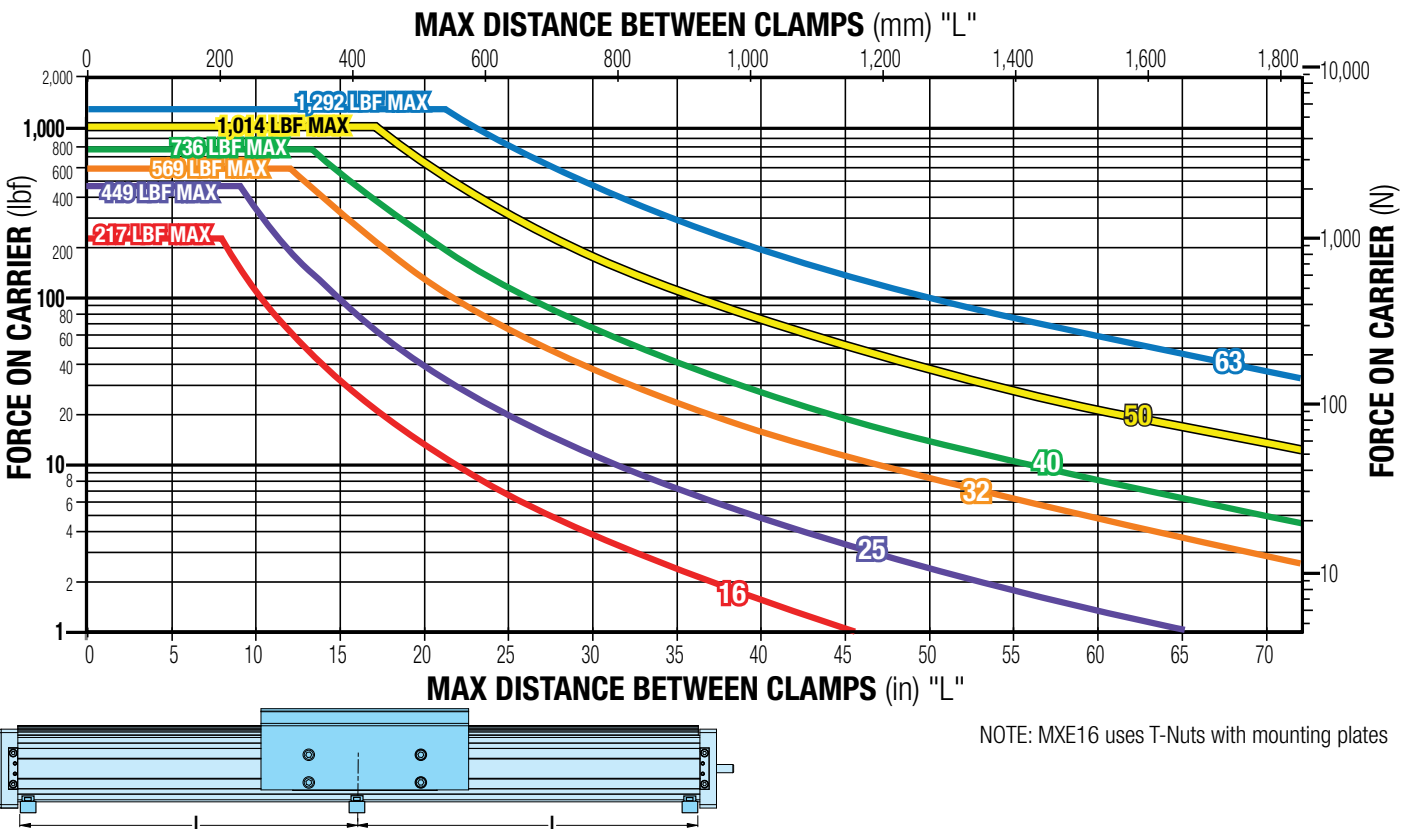



# SCREW CRITICAL SPEED CAPACITIES



sizeit.tolomatic.com for fast, accurate actuator selection

## MXE ACME SCREW CRITICAL SPEED

## MXE BALL SCREW CRITICAL SPEED

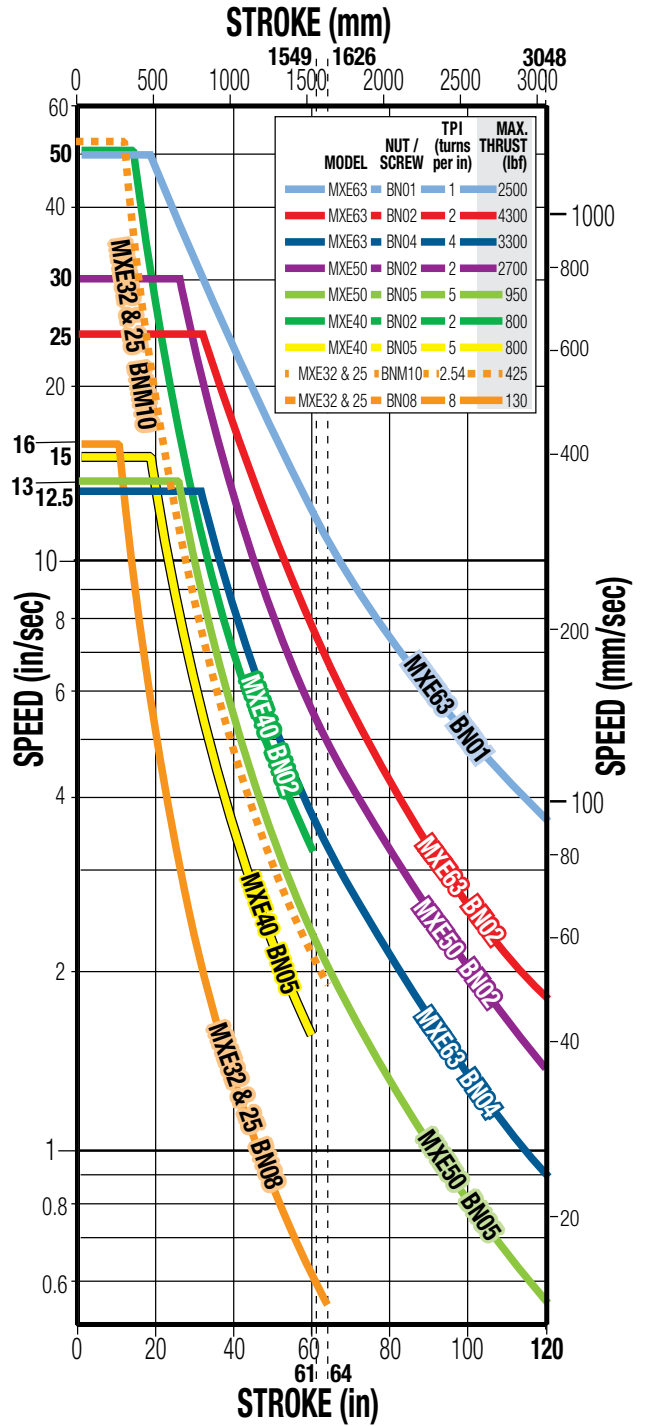
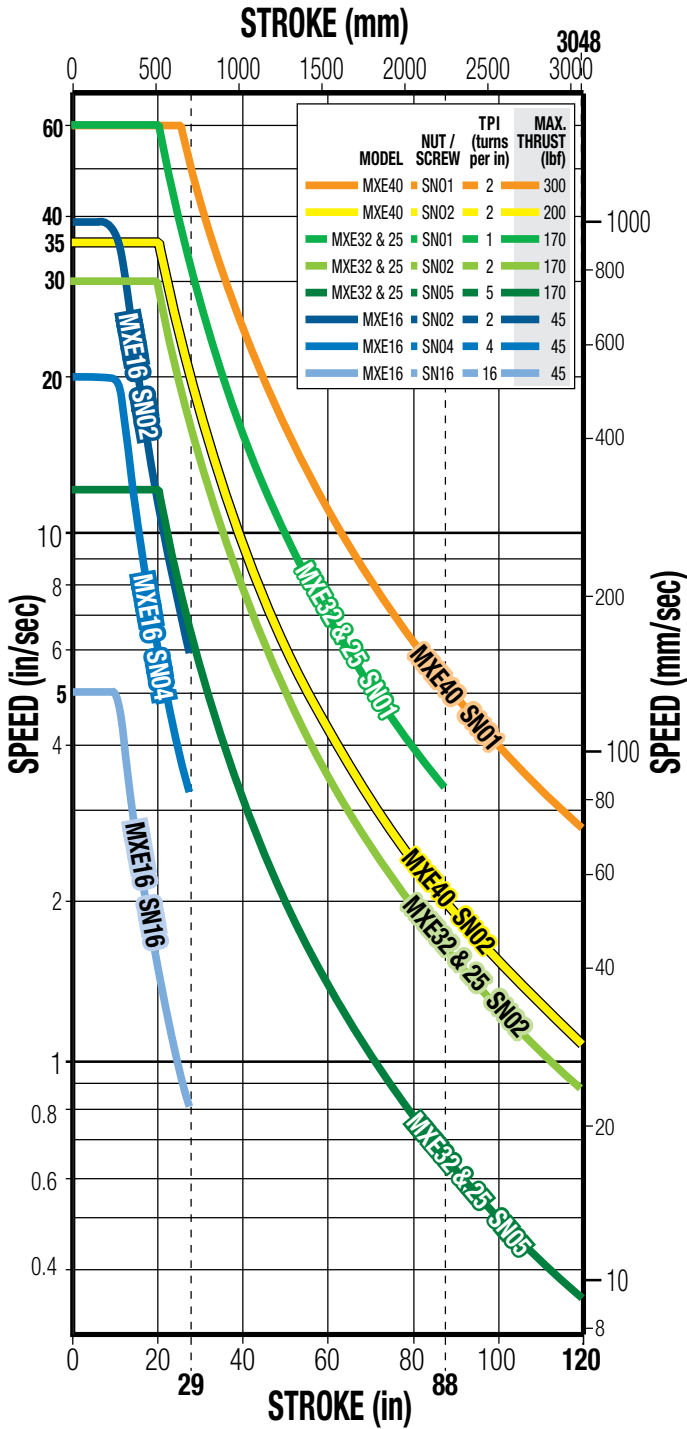

**!** \* Maximum thrust is the maximum continuous dynamic thrust subject to Thrust x Velocity limitation.

Dotted lines represent maximum stroke for screw selections.

For Screw PV limits, refer to the individual charts on the following pages for each actuator body size.

SCREW CODE	DESCRIPTION
SN	Solid Nut
BN	Ball Nut
BNL	Low Backlash Ball Nut

# MXE16, MXE25, MXE32, MXE40 ACME SCREW CRITICAL SPEED AND PV LIMITS

## MXE16: Critical Speed: 0.250" ACME

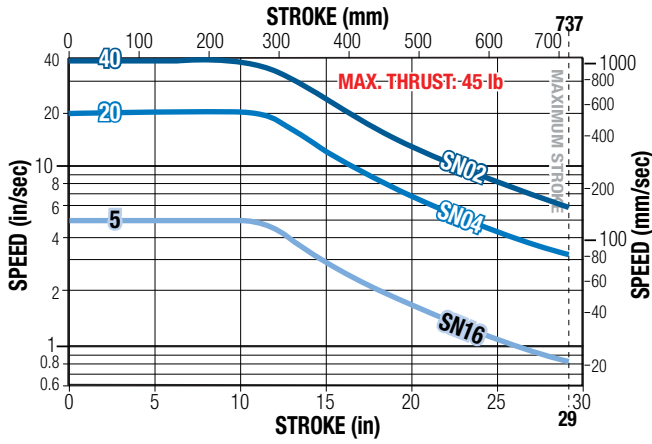

## MXE16: PV Limits: Acme Screws

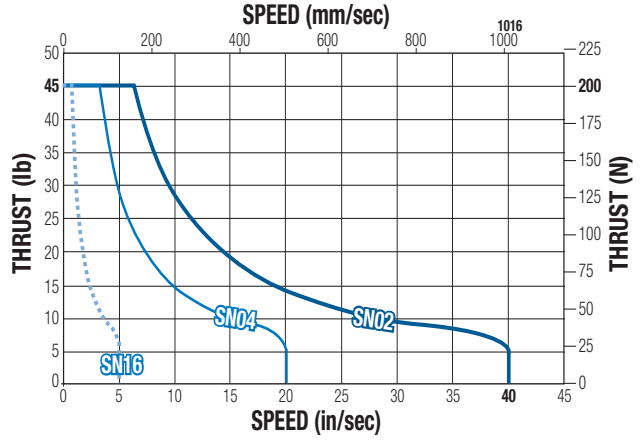

## MXE25, MXE32: Critical Speed: 0.5" ACME

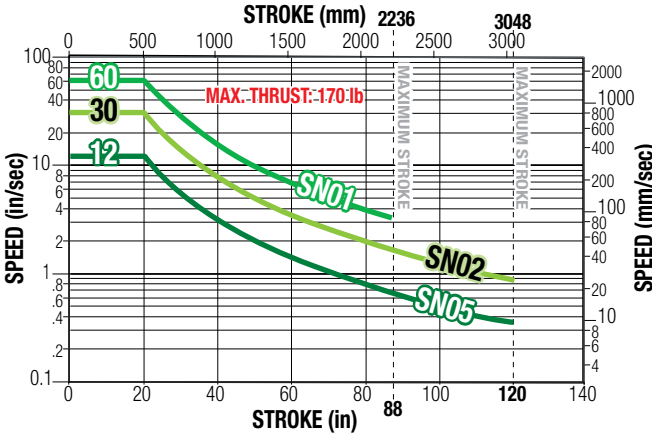

## MXE25, MXE32: PV Limits: Acme Screws

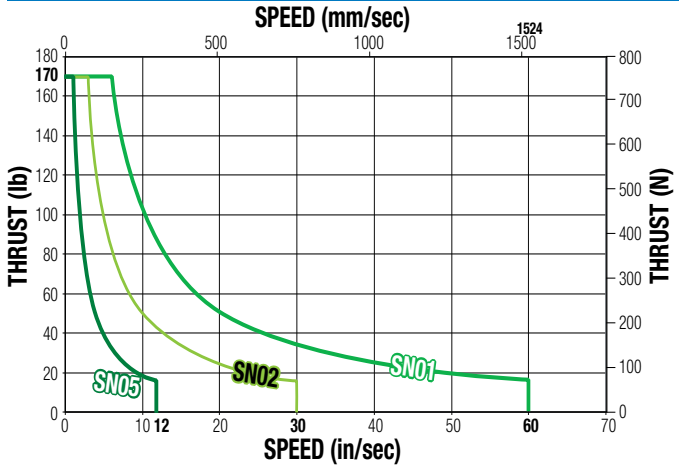

## MXE40: Critical Speed: 0.625" & .75" ACME

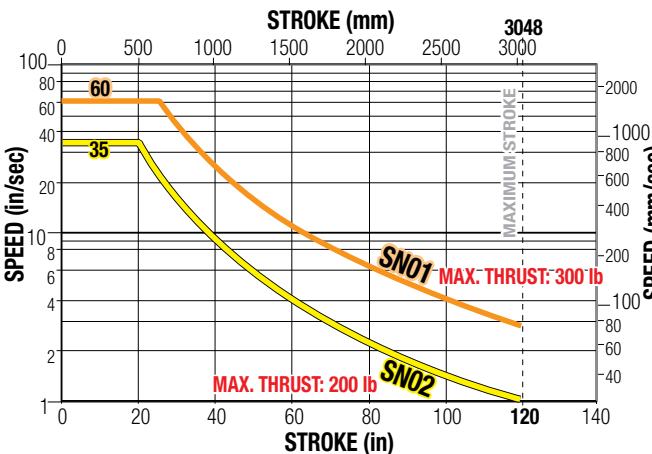

## MXE40: PV Limits: Acme Screws

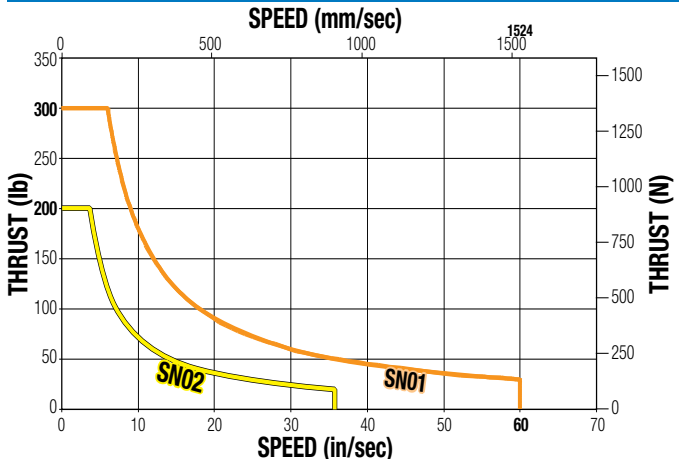

\* Maximum thrust is the maximum continuous dynamic thrust subject to Thrust x Velocity Limitation.

SN = Solid Nut

**PV LIMITS:** Any material which carries a sliding load is limited by heat buildup. The factors that affect heat generation rate in an application are the pressure on the nut in pounds per square inch and the surface velocity in feet per minute. The product of these factors provides a measure of the severity of an application.

$$\left( \frac{P}{\text{Max. Thrust Rating}} \right) \times \left( \frac{V}{\text{Max. Speed Rating}} \right) \leq 0.1$$



# MXE25, MXE32, MXE40 BALL SCREW CRITICAL SPEED AND THEORETICAL LIFE

**MXE25, MXE32: Critical Speed: Ball Screw**

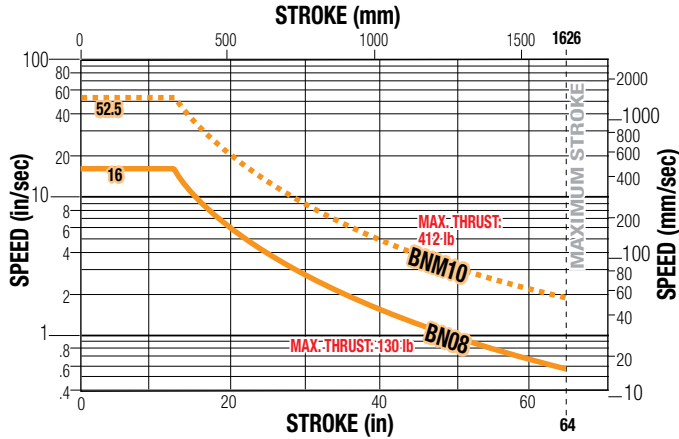

**MXE25, MXE32: Life: Ball Screw**

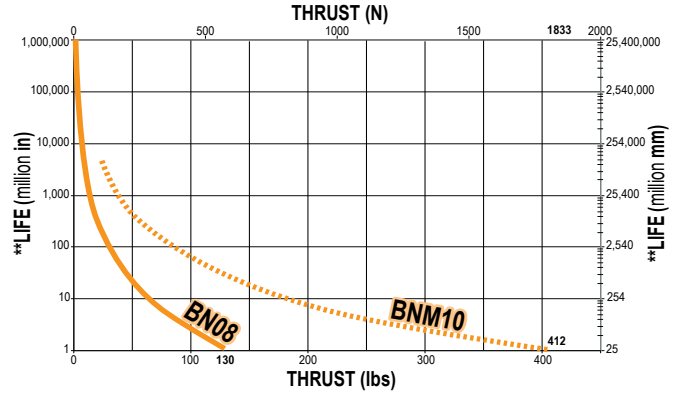

**MXE40: Critical Speed: Ball Screw**

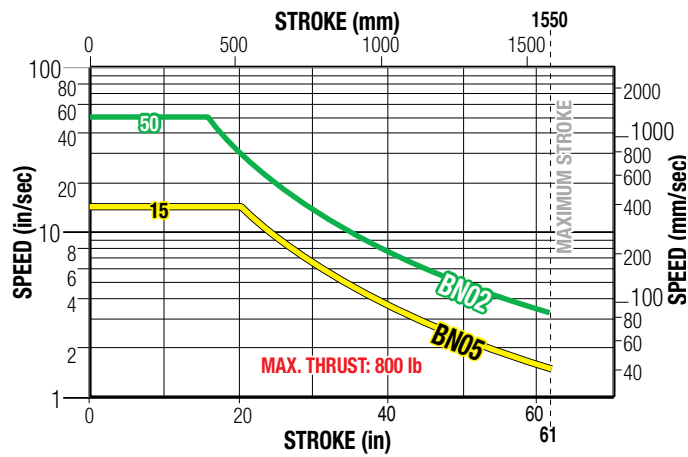

**MXE40: Life: Ball Screws**

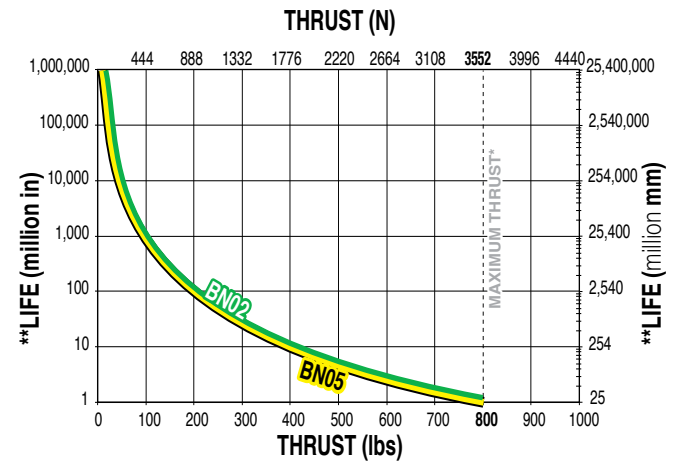

BN = Ball Nut

- ▲ \*Maximum thrust reflects 90% reliability for 25 million linear millimeters of travel.
- \*\*Life indicates theoretical maximum life of screw only, under ideal conditions and does not indicate expected life of actuator.

[sizeit.tolomatic.com](http://sizeit.tolomatic.com) for fast, accurate actuator selection

[sizeit.tolomatic.com](http://sizeit.tolomatic.com) for fast, accurate actuator selection or call Tolomatic (1-800-328-2174) with application information. We will provide any assistance needed to determine the proper MXE screw-driven actuator.

[tolomatic.com/ask](http://tolomatic.com/ask) Technical support before and after purchase

# MXE50, MXE63 BALL SCREW CRITICAL SPEED AND THEORETICAL LIFE

**MXE50: Critical Speed: Ball Screw**

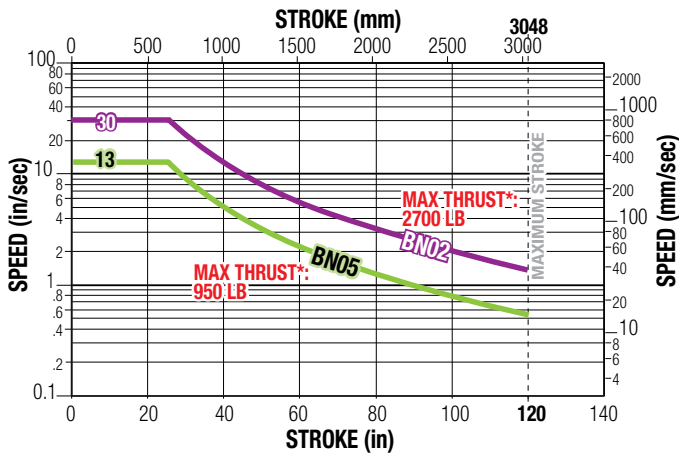

**MXE50: Life: Ball Screw**

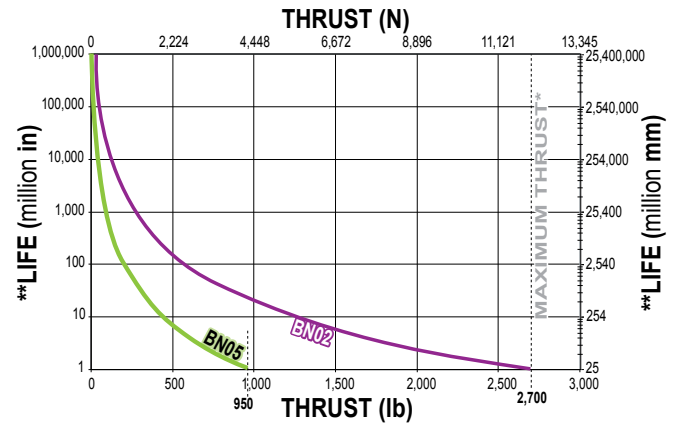

**MXE63: Critical Speed: Ball Screw**

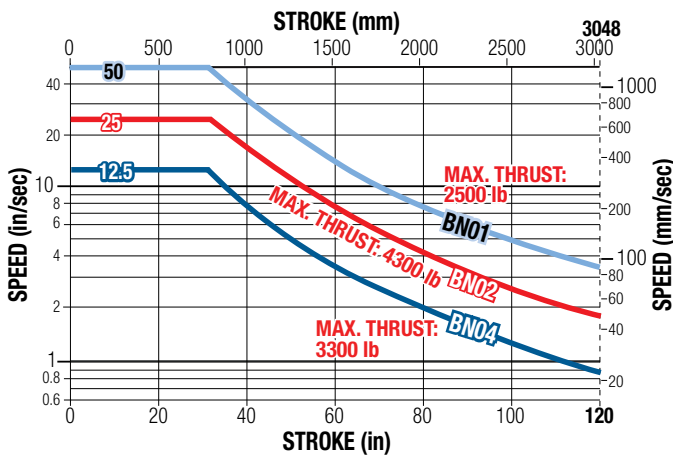

**MXE63: Life: 1", Ball Screw**

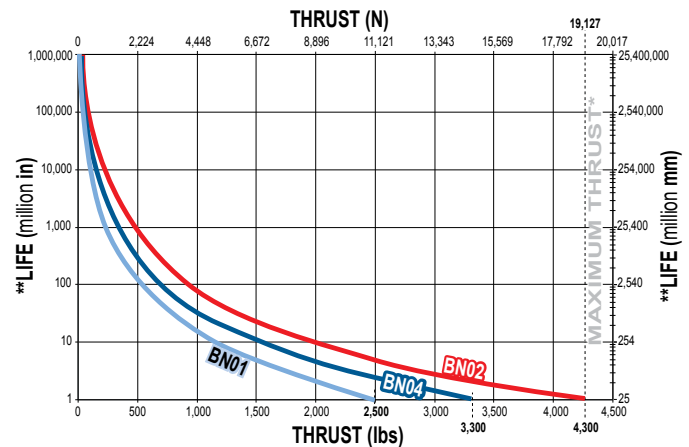

BN = Ball Nut

**⚠** \*Maximum thrust reflects 90% reliability for 25 million linear millimeters of travel.

\*\*Life indicates theoretical maximum life of screw only, under ideal conditions and does not indicate expected life of actuator.

[sizeit.tolomatic.com](http://sizeit.tolomatic.com) for fast, accurate actuator selection

[sizeit.tolomatic.com](http://sizeit.tolomatic.com) for fast, accurate actuator selection or call Tolomatic (1-800-328-2174) with application information. We will provide any assistance needed to determine the proper MXE screw-driven actuator.

[tolomatic.com/ask](http://tolomatic.com/ask) Technical support before and after purchase

# S-SOLID BEARING ACTUATOR DIMENSIONS

	MXE16	MXE25	MXE32	MXE40	MXE50	MXE63
A	69.1	96.3	100.9	125.2	141.7	211.3
B	72.1	100.6	105.1	130	147.8	216.2
C	12.7	23.4	12.7	16	33.3	47.8
D	42.2	57.2	55.4	75.9	88.1	110.0
E	48.0	58.4	77.8	89.2	112.8	139.7
F	40.1	55.4	72.6	88.2	104.1	142.0
G	21.1	24.1	30.7	39.1	46.2	58.4
H	35.1	47.5	47.5	-	-	-
I	8.1	7.6	7.6	-	-	-
J	16.8	25.7	25.7	-	-	-
K	33.3	Ø33.0	Ø33.0	Ø55.6	Ø68.3	Ø76.5
L	M3x0.5 (4)	M5x0.8 (8)	M5x0.8 (8)	M6x1.0 (4)	M6x1.0 (4)	M6x1.0 (4)
M	Ø4.78 (2)	Ø4.01 (2)	Ø4.01 (2)	Ø4.80 (2)	Ø4.78 (2)	Ø4.78 (2)
N	104.6	134.9	153	200	200.9	307.6
O	30.0	39.9	45	-	47.8	-
P	-	25.4	25.4	25.4	63.5	76.2
Q	-	27.2	28	41.3	31.8	38.1
R	-	M6x1.0 (2)	M8x1.25 (2)	M8x1.25 (2)	M10x1.5 (2)	M10x1.5 (2)
S	-	M6x1.0 (2)	M8x1.25 (2)	M8x1.25 (2)	M10x1.5 (2)	M10x1.5 (2)
T	M4x0.7 (6)	M6x1.0 (6)	M8x1.25 (6)	M8x1.25 (8)	M10x1.5 (6)	M10x1.5 (8)
U	30.0	30.0	44.0	51.0	65.8	82.6
V	-	-	-	Ø63.2	Ø76.5	Ø76.5
W	-	-	-	M5x0.8 (4)	M5x0.8 (4)	M5x0.8 (4)
X	-	-	-	15°	15°	15°
AA	30.00	42.00	55.37	64.00	78.74	100.00

Dimensions in millimeters

	MXE16	MXE25	MXE32	MXE40	MXE50	MXE63
A	2.72	3.79	3.97	4.93	5.58	8.32
B	2.84	3.96	4.14	5.12	5.82	8.51
C	0.50	0.92	0.50	0.63	1.31	1.88
D	1.66	2.25	2.18	2.99	3.47	4.33
E	1.89	2.30	3.06	3.51	4.44	5.50
F	1.58	2.18	2.86	3.47	4.10	5.59
G	0.83	0.95	1.21	1.54	1.82	2.30
H	1.38	1.87	1.87	-	-	-
I	0.32	0.30	0.30	-	-	-
J	0.66	1.01	1.01	-	-	-
K	1.31	Ø1.30	Ø1.30	Ø2.19	Ø2.69	Ø3.01
L	M3x0.5 (4)	M5x0.8 (8)	M5x0.8 (8)	M6x1.0 (4)	M6x1.0 (4)	M6x1.0 (4)
M	Ø0.188 (2)	Ø0.158 (2)	Ø0.158 (2)	Ø0.189 (2)	Ø0.188 (2)	Ø0.188 (2)
N	4.12	5.31	6.02	7.87	7.91	12.11
O	1.18	1.57	1.77	-	1.88	-
P	-	1.00	1.00	1.00	2.50	3.00
Q	-	1.07	1.10	1.63	1.25	1.50
R	-	1/4-20 (2)	1/4-20 (2)	1/4-20 (2)	3/8-16 (2)	3/8-16 (2)
S	-	#10-32 (2)	1/4-20 (2)	5/16-18 (2)	3/8-16 (2)	3/8-16 (2)
T	#8-32 (6)	1/4-20 (6)	1/4-20 (6)	5/16-18 (8)	3/8-16 (6)	3/8-16 (8)
U	1.18	1.18	1.73	2.00	2.59	3.25
V	-	-	-	Ø2.49	Ø3.01	Ø3.01
W	-	-	-	M5x0.8 (4)	M5x0.8 (4)	M5x0.8 (4)
X	-	-	-	15°	15°	15°
AA	1.18	1.65	2.18	2.52	3.10	3.94

Dimensions in inches

Y (Shaft length)	MXE16	MXE25	MXE32	MXE40	MXE50	MXE63
LMI	16.3	14.0	14.0	17.5	34.3	34.3
17 FRAME RP	22.1	-	-	-	-	-
23 FRAME RP	-	50.5	50.5	50.5	53.3	48.8
34 FRAME RP	-	55.9	55.9	55.9	53.3	48.8
56 FRAME RP	-	-	-	-	-	48.8
Z (Shaft dia.)	MXE16	MXE25	MXE32	MXE40	MXE50	MXE63
LMI (BN02)	3.96	6.35	6.35	7.92	12.70	-
LMI (all others)	3.96	6.35	6.35	9.98	12.70	12.70
RP (BN02)	3.96	6.35	6.35	6.35	12.70	12.70
RP (all others)	3.96	6.35	6.35	9.53	12.70	12.70

Dimensions in millimeters

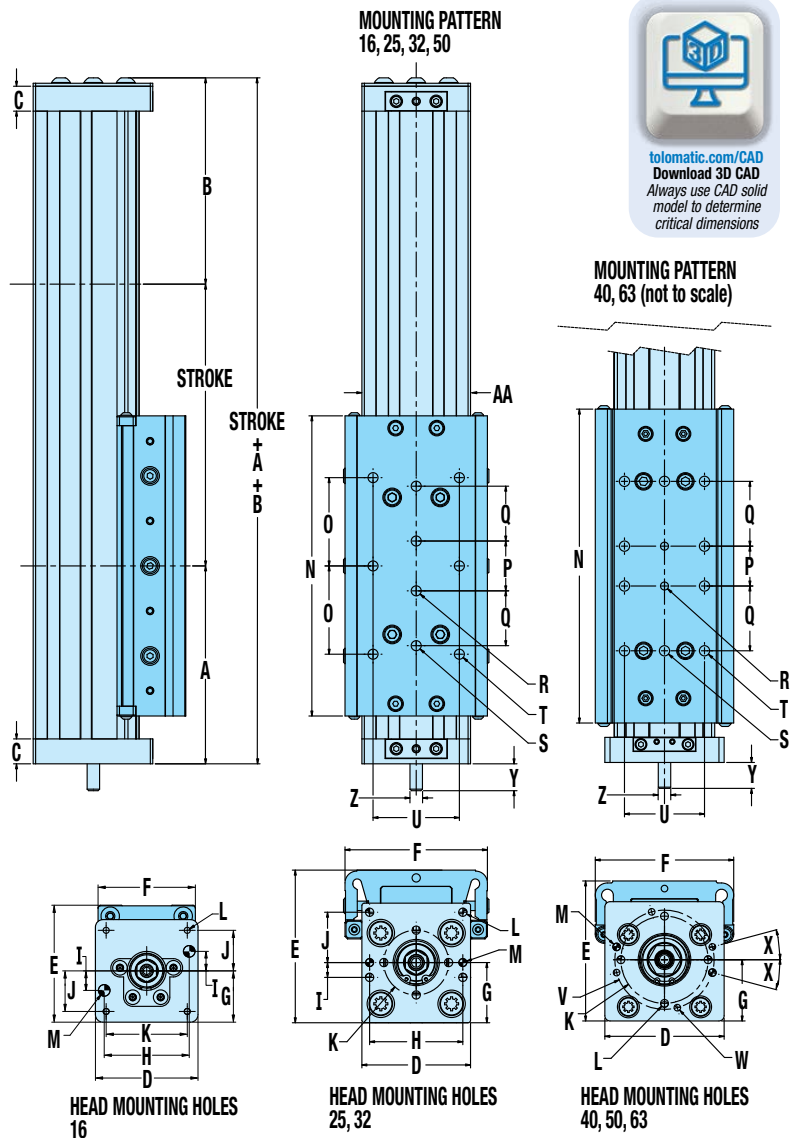

Y (Shaft length)	MXE16	MXE25	MXE32	MXE40	MXE50	MXE63
LMI	0.64	0.55	0.55	0.69	1.35	1.35
17 FRAME RP	0.87	-	-	-	-	-
23 FRAME RP	-	1.99	1.99	1.99	2.10	1.92
34 FRAME RP	-	2.20	2.20	2.20	2.10	1.92
56 FRAME RP	-	-	-	-	-	1.92
Z (Shaft dia.)	MXE16	MXE25	MXE32	MXE40	MXE50	MXE63
LMI (BN02)	0.156	0.25	0.25	0.312	0.5	-
LMI (all others)	0.156	0.25	0.25	0.393	0.5	0.5
RP (BN02)	0.156	0.25	0.25	0.25	0.5	0.5
RP (all others)	0.156	0.25	0.25	0.375	0.5	0.5

Dimensions in inches

# S-SOLID BEARING OPTION DIMENSIONS

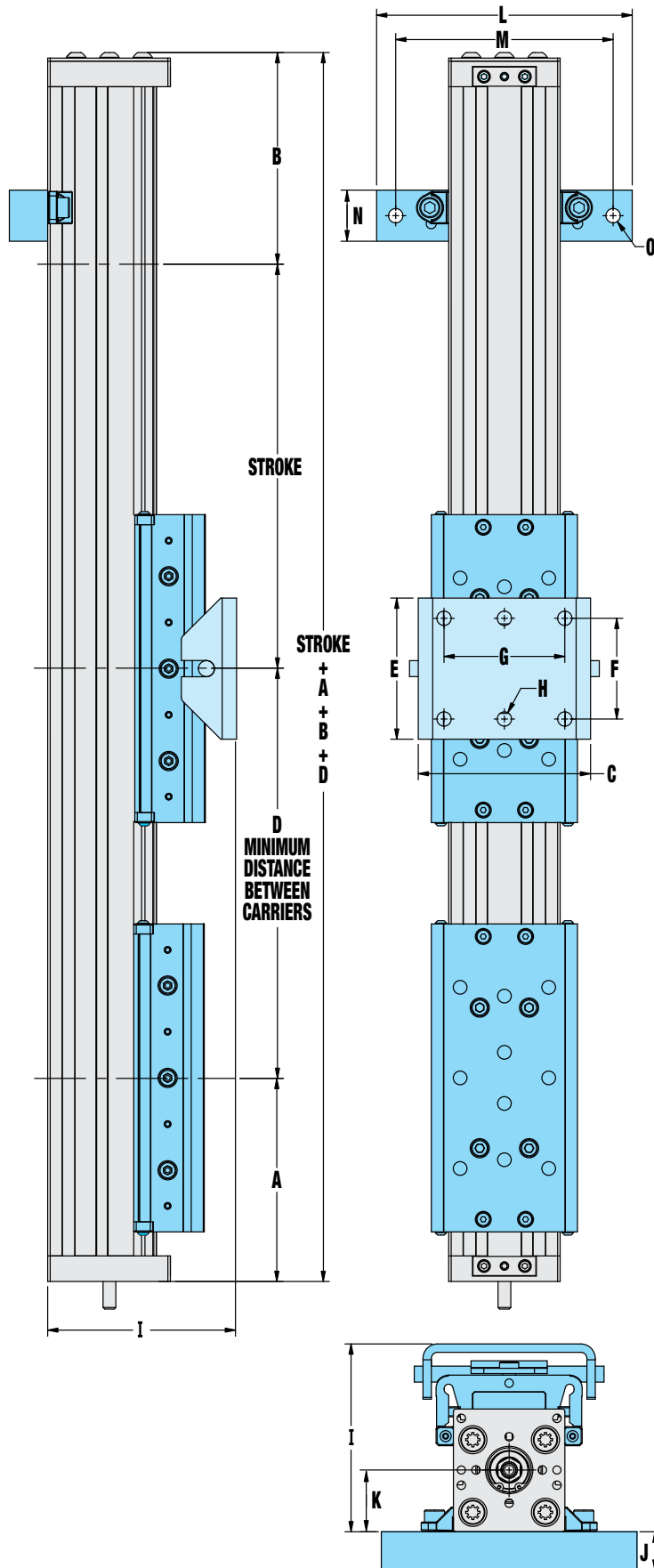

	MXE16	MXE25	MXE32	MXE40	MXE50	MXE63
A	69.1	96.3	100.9	125.2	141.7	211.3
B	72.1	100.6	105.1	130	147.8	216.2
<b>AUXILIARY CARRIER</b>						
D	127.0	152.4	177.8	215.9	218.4	330.2
<b>FLOATING MOUNT</b>						
C	47.2	64.1	93.3	109.7	128.0	154.9
E	24.9	31.8	70.1	100.0	100.0	127.0
F	11.9	15.9	50.0	74.9	80.0	100.1
G	-	-	-	55.1	-	70.1
H*	Ø4.6 (2)	Ø6.1 (2)	Ø7.1 (2)	Ø7.1 (4)	Ø9.1 (2)	Ø8.6 (4)
I	57.9	71.0	93.3	108.2	133.1	156.7
<b>MOUNTING PLATE/TUBE CLAMP KITS</b>						
J**	12.7	25.4	19.1	16.0	31.8	25.4
J***	-	35.1	28.7	25.4	31.8	25.4
K	21.1	24.1	30.7	39.1	46.2	58.4
L	63.5	101.6	127.0	127.0	142.2	203.2
M	47.8	86.0	108.0	112.0	127.0	177.8
N	25.4	25.4	25.4	20.0	20.0	25.4
O	Ø5.6 (2)	Ø5.6 (2)	Ø7.1 (2)	Ø7.1 (2)	Ø7.1 (2)	Ø10.7 (2)

Dimensions in millimeters

\* MXE16, MXE25, MXE32 & MXE50 USE 2 CENTER HOLES, MXE40 & MXE63 USE 4 CORNER HOLES

\*\* MOUNTING PLATE THICKNESS FOR 23 FRAME MOTORS (17 FRAME MOTORS ON MXE16)

\*\*\* MOUNTING PLATE THICKNESS FOR 34 FRAME MOTORS (AND 56 FRAME MOTORS ON MXE63)

	MXE16	MXE25	MXE32	MXE40	MXE50	MXE63
A	2.72	3.79	3.97	4.93	5.58	8.32
B	2.84	3.96	4.14	5.12	5.82	8.51
<b>AUXILIARY CARRIER</b>						
D	5.00	6.00	7.00	8.50	8.60	13.00
<b>FLOATING MOUNT</b>						
C	1.86	2.52	3.37	4.32	5.04	6.10
E	0.98	1.25	2.76	3.94	3.94	5.00
F	0.47	0.63	1.97	2.95	3.15	3.94
G	-	-	-	2.17	-	2.76
H*	Ø0.18 (2)	Ø0.24 (2)	Ø0.28 (2)	Ø0.28 (4)	Ø0.36 (2)	Ø0.34 (4)
I	2.28	2.80	3.67	4.26	5.24	6.17
<b>MOUNTING PLATE/TUBE CLAMP KITS</b>						
J**	0.50	1.00	0.75	0.63	1.25	1.00
J***	-	1.38	1.13	1.00	1.25	1.00
K	0.83	0.95	1.21	1.54	1.82	2.30
L	2.50	4.00	5.00	5.00	5.60	8.00
M	1.88	3.39	4.25	4.41	5.00	7.00
N	1.00	1.00	1.00	0.79	0.79	1.00
O	Ø0.22 (2)	Ø0.22 (2)	Ø0.28 (2)	Ø0.28 (2)	Ø0.28 (2)	Ø0.42 (2)

Dimensions in inches

\* MXE16, MXE25, MXE32 & MXE50 USE 2 CENTER HOLES, MXE40 & MXE63 USE 4 CORNER HOLES

\*\* MOUNTING PLATE THICKNESS FOR 23 FRAME MOTORS (17 FRAME MOTORS ON MXE16)

\*\*\* MOUNTING PLATE THICKNESS FOR 34 FRAME MOTORS (AND 56 FRAME MOTORS ON MXE63)

NOTE: MXE16 uses **MP** (mounting plate) with included T-nuts

 [tolomatic.com/CAD](http://tolomatic.com/CAD)  
**Download 3D CAD**  
*Always use CAD solid model to determine critical dimensions*

# P-PROFILED RAIL ACTUATOR DIMENSIONS

	MXE16	MXE25	MXE32	MXE40	MXE50	MXE63
A	69.1	96.3	100.9	125.2	141.7	211.3
B	72.1	100.6	105.1	130.0	147.8	216.2
C	12.7	23.4	12.7	16.0	33.3	47.8
D	42.2	57.2	55.4	75.9	88.0	110.0
E	52.1	66.1	77.4	95.7	124.5	145.0
F	45.7	67.4	82.6	97.8	117.3	143.5
G	21.1	24.1	30.7	39.1	46.2	58.4
H	35.1	47.5	47.5	-	-	-
I	8.1	7.6	7.6	-	-	-
J	16.8	25.7	25.7	-	-	-
K	33.3	Ø33.0	Ø33.0	Ø55.6	Ø68.3	Ø55.6
L	M3x0.5 (4)	M5x0.8 (8)	M5x0.8 (8)	M6x1.0 (4)	M6x1.0 (4)	M6x1.0 (4)
M	Ø4.78 (2)	Ø4.01 (2)	Ø4.01 (2)	Ø4.80 (2)	Ø4.78 (2)	Ø4.78 (2)
N	110.0	135.0	170.0	200	215.9	207.6
O	40.0	40.0	27.2	25.4	25.4	39.9
P	-	-	85.6	114.3	69.9	130.0
Q	M4x0.7 (6)	M6x1.0 (6)	M8x1.25 (8)	M8x1.25 (8)	M8x1.25 (8)	M10x1.5 (8)
R	28.00	40.00	50.00	72.00	79.38	98.30
S	-	-	-	Ø63.2	Ø76.5	Ø76.5
T	-	-	-	M5x0.8 (4)	M5x0.8 (4)	M5x0.8 (4)
U	-	-	-	15°	15°	15°
V	40.00	40.00	45.00	63.50	38.10	65.00
W*	Ø4.045 / 4.020 ∇ 6.35	Ø6.045 / 6.020 ∇ 6.35	Ø8.045 / 8.020 ∇ 9.53	Ø8.045 / 8.020 ∇ 12.70	Ø8.045 / 8.020 ∇ 12.70	Ø10.045 / 10.020 ∇ 12.70
X	46.0	58.5	77.4	89.7	119.7	140.0
AA	30.00	40.00	54.00	64.00	78.74	100.00
BB	35.50	48.60	62.87	73.50	93.74	115.00

Dimensions in millimeters

\*DOWEL HOLES

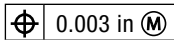

	MXE16	MXE25	MXE32	MXE40	MXE50	MXE63
A	2.72	3.79	3.97	4.93	5.58	8.32
B	2.84	3.96	4.14	5.12	5.82	8.51
C	0.50	0.92	0.50	0.63	1.31	1.88
D	1.66	2.25	2.18	2.99	3.47	4.33
E	2.05	2.60	3.05	3.77	4.90	5.71
F	1.80	2.65	3.25	3.85	4.62	5.65
G	0.83	0.95	1.21	1.54	1.82	2.30
H	1.38	1.87	1.87	-	-	-
I	0.32	0.30	0.30	-	-	-
J	0.66	1.01	1.01	-	-	-
K	1.31	Ø1.30	Ø1.30	Ø2.19	Ø2.69	Ø2.19
L	M3x0.5 (4)	M5x0.8 (8)	M5x0.8 (8)	M6x1.0 (4)	M6x1.0 (4)	M6x1.0 (4)
M	Ø0.188 (2)	Ø0.158 (2)	Ø0.158 (2)	Ø0.189 (2)	Ø0.188 (2)	Ø0.188 (2)
N	4.33	5.31	6.69	7.87	8.50	12.11
O	1.58	1.57	1.07	1.00	1.00	1.57
P	-	-	3.37	4.50	2.75	5.12
Q	#8-32 (6)	1/4-20 (6)	5/16-18 (8)	5/16-18 (8)	5/16-18 (8)	3/18-16 (8)
R	1.102	1.575	1.969	2.835	3.125	3.870
S	-	-	-	Ø2.49	Ø3.01	Ø3.01
T	-	-	-	M5x0.8 (4)	M5x0.8 (4)	M5x0.8 (4)
U	-	-	-	15°	15°	15°
V	1.575	1.575	1.772	2.500	1.500	2.559
W*	Ø0.1583 / .1573 (2) ∇ .250	Ø0.2520 / .2510 (2) ∇ .250	Ø0.3145 / .3135 (2) ∇ .375	Ø0.3145 / .3135 (2) ∇ .500	Ø0.3145 / .3135 (2) ∇ .500	Ø0.3770 / .3760 (2) ∇ .500
X	1.81	2.30	3.05	3.53	4.71	5.51
AA	1.18	1.58	2.13	2.52	3.10	3.94
BB	1.40	1.91	2.48	2.89	3.69	4.53

Dimensions in inches

Y (Shaft length)	MXE16	MXE25	MXE32	MXE40	MXE50	MXE63
LMI	16.3	14	14	17.5	34.3	34.3
17 FRAME RP	22.1	-	-	-	-	-
23 FRAME RP	-	50.5	50.5	50.5	53.3	48.8
34 FRAME RP	-	55.9	55.9	55.9	53.3	48.8
56 FRAME RP	-	-	-	-	-	48.8
Z (Shaft dia.)	MXE16	MXE25	MXE32	MXE40	MXE50	MXE63
LMI (BN02)	3.96	6.35	6.35	7.92	12.70	-
LMI (all others)	3.96	6.35	6.35	9.98	12.70	12.70
RP (BN02)	3.96	6.35	6.35	6.35	12.70	12.70
RP (all others)	3.96	6.35	6.35	9.53	12.70	12.70

Dimensions in millimeters

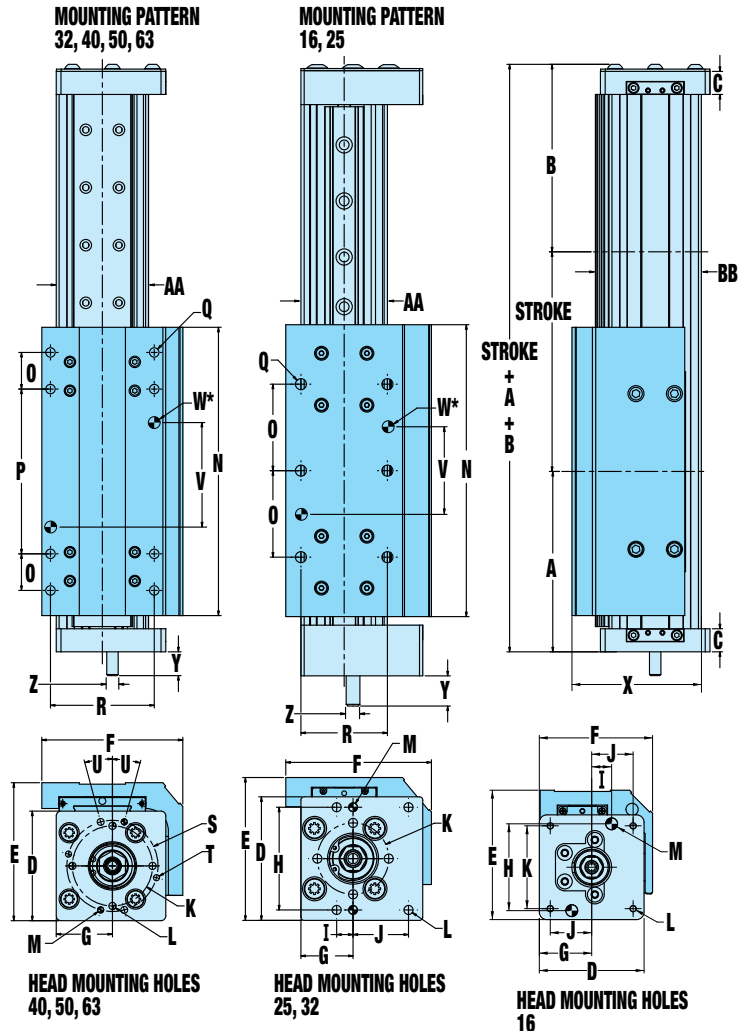

Y (Shaft length)	MXE16	MXE25	MXE32	MXE40	MXE50	MXE63
LMI	0.64	0.55	0.55	0.69	1.35	1.35
17 FRAME RP	0.87	-	-	-	-	-
23 FRAME RP	-	1.99	1.99	1.99	2.10	1.92
34 FRAME RP	-	2.2	2.2	2.2	2.10	1.92
56 FRAME RP	-	-	-	-	-	1.92
Z (Shaft dia.)	MXE16	MXE25	MXE32	MXE40	MXE50	MXE63
LMI (BN02)	0.156	0.25	0.25	0.312	0.5	-
LMI (all others)	0.156	0.25	0.25	0.393	0.5	0.5
RP (BN02)	0.156	0.25	0.25	0.25	0.5	0.5
RP (all others)	0.156	0.25	0.25	0.375	0.5	0.5

Dimensions in inches

# P-PROFILED RAIL OPTION DIMENSIONS

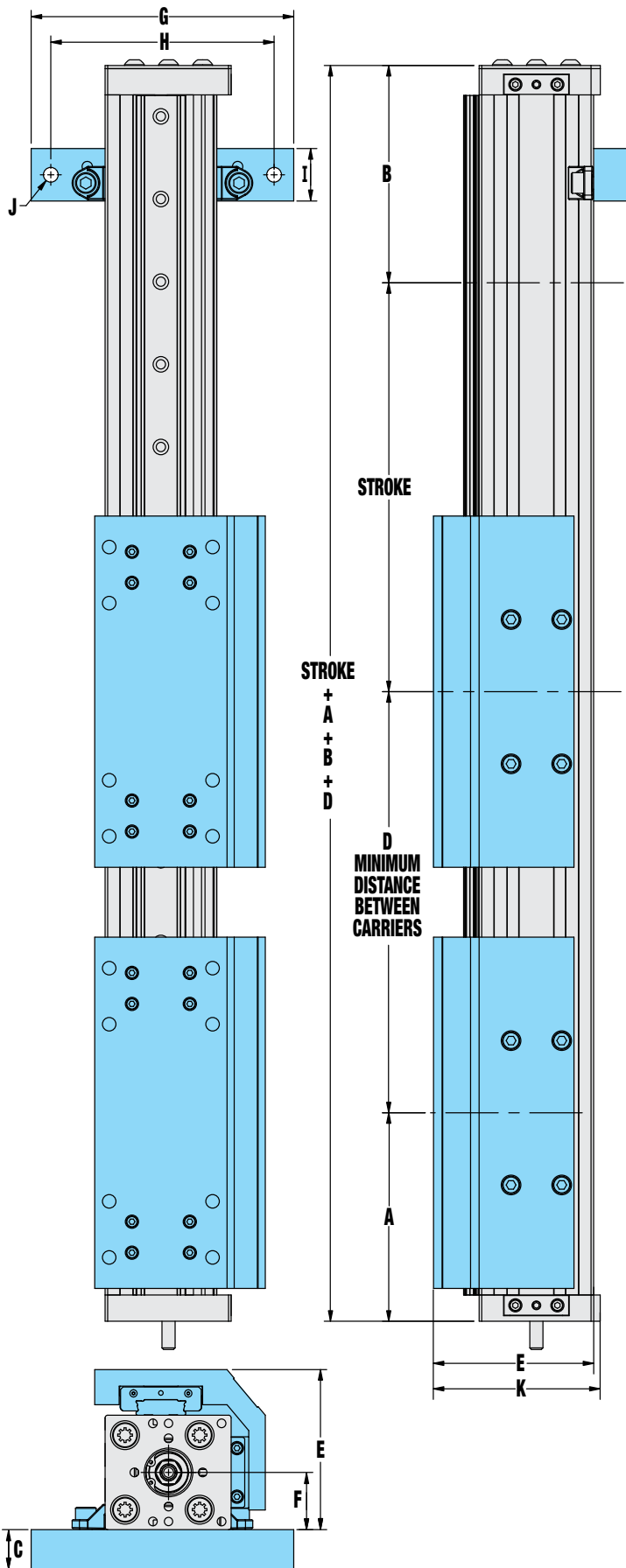

	MXE16	MXE25	MXE32	MXE40	MXE50	MXE63
A	69.1	96.3	100.9	125.2	141.7	211.3
B	72.1	100.6	105.1	130	147.8	216.2

### AUXILIARY CARRIER

D	127.0	152.4	177.8	215.9	218.4	330.2
---	-------	-------	-------	-------	-------	-------

### MOUNTING PLATE/TUBE CLAMP KITS

C*	12.7	25.4	19.1	16.0	31.8	25.4
C**	-	35.1	28.7	25.4	31.8	25.4
E	46.0	58.5	77.4	89.7	119.7	140.0
F	21.1	24.1	30.7	39.1	46.2	58.4
G	63.5	101.6	127.0	127.0	142.2	203.2
H	47.8	86.0	108.0	112.0	127.0	177.8
I	25.4	25.4	25.4	20.0	20.0	25.4
J	Ø5.6 (2)	Ø5.6 (2)	Ø7.1 (2)	Ø7.1 (2)	Ø7.1 (2)	Ø10.7 (2)
K	52.1	66.1	77.4	95.7	124.5	145.0

Dimensions in millimeters

\* MOUNTING PLATE THICKNESS FOR 23 FRAME MOTORS (17 FRAME MOTORS ON MXE16)

\*\* MOUNTING PLATE THICKNESS FOR 34 FRAME MOTORS (AND 56 FRAME MOTORS ON MXE63)

	MXE16	MXE25	MXE32	MXE40	MXE50	MXE63
A	2.72	3.79	3.97	4.93	5.58	8.32
B	2.84	3.96	4.14	5.12	5.82	8.51

### AUXILIARY CARRIER

D	5.00	6.00	7.00	8.50	8.60	13.00
---	------	------	------	------	------	-------

### MOUNTING PLATE/TUBE CLAMP KITS

C*	0.50	1.00	0.75	0.63	1.25	1.00
C**	-	1.38	1.13	1.00	1.25	1.00
E	1.81	2.30	3.05	3.53	4.71	5.51
F	0.83	0.95	1.21	1.54	1.82	2.30
G	2.50	4.00	5.00	5.00	5.60	8.00
H	1.88	3.39	4.25	4.41	5.00	7.00
I	1.00	1.00	1.00	0.79	0.79	1.00
J	Ø.22 (2)	Ø.22 (2)	Ø.28 (2)	Ø.28 (2)	Ø.28 (2)	Ø.42 (2)
K	2.05	2.60	3.05	3.77	1.90	5.71

Dimensions in inches

\* MOUNTING PLATE THICKNESS FOR 23 FRAME MOTORS (17 FRAME MOTORS ON MXE16)

\*\* MOUNTING PLATE THICKNESS FOR 34 FRAME MOTORS (AND 56 FRAME MOTORS ON MXE63)

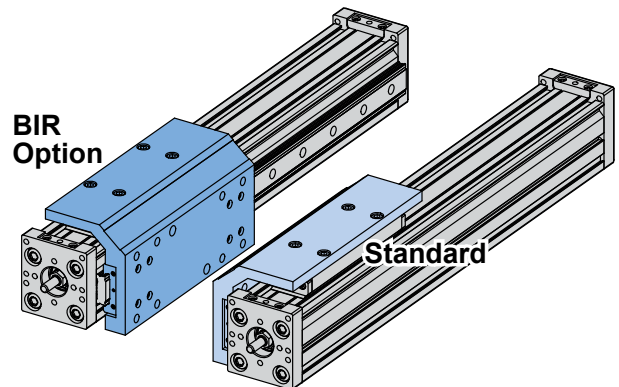



[tolomatic.com/CAD](http://tolomatic.com/CAD)  
 Download 3D CAD  
 Always use CAD solid model to determine critical dimensions

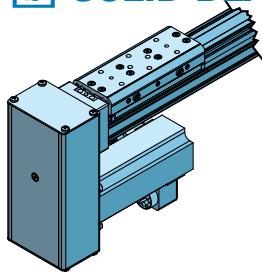

# REVERSE PARALLEL MOTOR MOUNTING

## S-SOLID BEARING



**REVERSE-PARALLEL BOTTOM (RPB)**  
mounting surface shown UP  
**BOTTOM MOUNT**

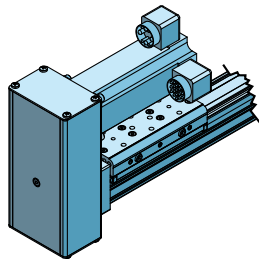

**REVERSE-PARALLEL TOP (RPT)**  
mounting surface shown UP  
**TOP MOUNT**

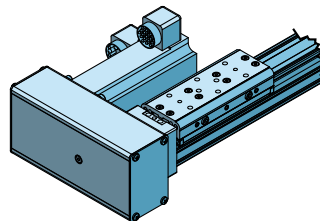

**REVERSE-PARALLEL LEFT (RPL)**  
mounting surface shown UP  
**SIDE MOUNT (Left Shown)**

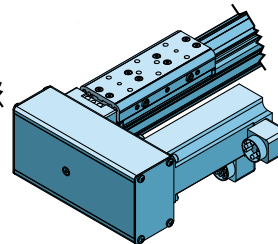

**REVERSE-PARALLEL RIGHT (RPR)**  
mounting surface shown UP  
**SIDE MOUNT (Right Shown)**

ACTUATOR	MOTOR	WEIGHT OF REDUCTION DRIVE				REDUCTION INERTIA AT MOTOR SHAFT			
		1:1	2:1	1:1	2:1	1:1	2:1	1:1	2:1
		kg	kg	lbs	lbs	kg-cm <sup>2</sup>	kg-cm <sup>2</sup>	lb-in <sup>2</sup>	lb-in <sup>2</sup>
<b>MXE16S</b>	NEMA 17 FRAME SIZE MOTOR	0.25	0.27	0.55	0.58	0.0029	0.0059	0.001	0.002
<b>MXE25S</b>	ALL FRAME SIZE MOTORS	0.93	0.93	2.06	2.06	0.2559	0.3291	0.087	0.112
<b>MXE32S</b>	ALL FRAME SIZE MOTORS	0.93	0.93	2.06	2.06	0.2559	0.3291	0.087	0.112
<b>MXE40S</b>	ALL FRAME SIZE MOTORS	0.93	0.93	2.06	2.06	0.2559	0.3291	0.087	0.112
<b>MXE50S</b>	NEMA 23-FRAME SIZE MOTOR	1.58	2.00	3.49	4.41	0.2634	0.7433	0.090	0.254
	NEMA 34-FRAME SIZE MOTOR	1.80	2.21	3.96	4.86	0.2634	0.7433	0.090	0.254
<b>MXE63S</b>	NEMA 23-FRAME SIZE MOTOR	1.58	2.00	3.49	4.41	0.2634	0.7433	0.090	0.254
	NEMA 34-FRAME SIZE MOTOR	1.79	2.19	3.94	4.84	0.2546	0.7345	0.087	0.251
	NEMA 56-FRAME SIZE MOTOR	1.91	2.31	4.20	5.10	0.2546	0.7345	0.087	0.251

REDUCTION EFFICIENCY: 0.95

[tolomatic.com/CAD](http://tolomatic.com/CAD)  
Download 3D CAD  
Always use CAD solid model to determine critical dimensions

## P-PROFILED RAIL BEARING

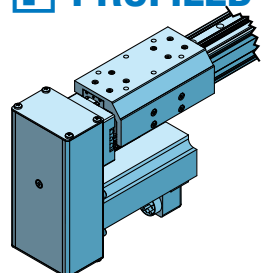

**REVERSE-PARALLEL BOTTOM (RPB)**  
mounting surface shown UP  
**BOTTOM MOUNT**

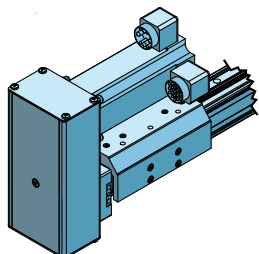

**REVERSE-PARALLEL TOP (RPT)**  
mounting surface shown UP  
**TOP MOUNT**

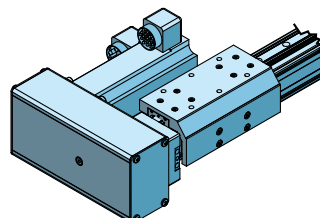

**REVERSE-PARALLEL LEFT (RPL)**  
mounting surface shown UP  
**SIDE MOUNT (Left Shown)**

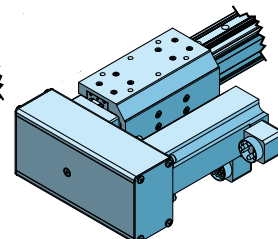

**REVERSE-PARALLEL RIGHT (RPR)**  
mounting surface shown UP  
**SIDE MOUNT (Right Shown)**

ACTUATOR	MOTOR	WEIGHT OF REDUCTION DRIVE				REDUCTION INERTIA AT MOTOR SHAFT			
		1:1	2:1	1:1	2:1	1:1	2:1	1:1	2:1
		kg	kg	lbs	lbs	kg-cm <sup>2</sup>	kg-cm <sup>2</sup>	lb-in <sup>2</sup>	lb-in <sup>2</sup>
<b>MXE16P</b>	NEMA 17 FRAME SIZE MOTOR	0.25	0.27	0.55	0.58	0.0029	0.0059	0.001	0.002
<b>MXE25P</b>	ALL FRAME SIZE MOTORS	0.93	0.93	2.06	2.06	0.2559	0.3291	0.087	0.112
<b>MXE32P</b>	ALL FRAME SIZE MOTORS	0.93	0.93	2.06	2.06	0.2559	0.3291	0.087	0.112
<b>MXE40P</b>	ALL FRAME SIZE MOTORS	0.93	0.93	2.06	2.06	0.2559	0.3291	0.087	0.112
<b>MXE50P</b>	NEMA 23-FRAME SIZE MOTOR	1.58	2.00	3.49	4.41	0.2634	0.7433	0.090	0.254
	NEMA 34-FRAME SIZE MOTOR	1.80	2.21	3.96	4.86	0.2634	0.7433	0.090	0.254
<b>MXE63P</b>	NEMA 23-FRAME SIZE MOTOR	1.58	2.00	3.49	4.41	0.2634	0.7433	0.090	0.254
	NEMA 34-FRAME SIZE MOTOR	1.79	2.19	3.94	4.84	0.2546	0.7345	0.087	0.251
	NEMA 56-FRAME SIZE MOTOR	1.91	2.31	4.20	5.10	0.2546	0.7345	0.087	0.251

REDUCTION EFFICIENCY: 0.95

[tolomatic.com/ask](http://tolomatic.com/ask)  
Technical support before and after purchase

# SWITCHES

## SPECIFICATIONS









MX products offer a wide range of sensing choices. There are 12 switch choices: reed, solid state PNP (sourcing) or solid state NPN (sinking); in normally open or normally closed; with flying leads or quick-disconnect.

Commonly used for end-of-stroke positioning, these switches allow drop-in installation anywhere along the entire actuator length. The one-piece design includes the retained fastening hardware and is designed for any open side or bottom slot on the MX. The internal piston magnet is a standard feature, therefore these switches can be installed in the field at any time.

Switches are used to send digital signals to PLC (programmable logic controller), TTL, CMOS circuit or other controller device. Switches contain reverse polarity protection. Solid state QD cables are shielded; shield should be terminated at flying lead end.

All switches are CE rated and are RoHS compliant. Switches feature bright red or yellow LED signal indicators; solid state switches also have green LED power indicators.



	Order Code	Lead	Switching Logic	Power LED	Signal LED	Operating Voltage	**Power Rating (Watts)	Switching Current (mA max.)	Current Consumption	Voltage Drop	Leakage Current	Temp. Range	Shock / Vibration
REED	<b>R</b> <b>Y</b>	5m	SPST Normally Open	—	Red	5 - 240 AC/DC	**10.0	100mA	—	3.0 V max.	—	14 to 158°F  [-10 to 70°C]	50 G / 9 G
	<b>R</b> <b>K</b>	QD*											
	<b>N</b> <b>Y</b>	5m	SPST Normally Closed	—	Yellow	5 - 110 AC/DC							
	<b>N</b> <b>K</b>	QD*											
SOLID STATE	<b>T</b> <b>Y</b>	5m	PNP (Sourcing) Normally Open	Green	Yellow	10 - 30 VDC	**3.0	100mA	20 mA @ 24V	2.0 V max.	0.05 mA max.		
	<b>T</b> <b>K</b>	QD*											
	<b>K</b> <b>Y</b>	5m	NPN (Sinking) Normally Open	Green	Red								
	<b>K</b> <b>K</b>	QD*											
	<b>P</b> <b>Y</b>	5m	PNP (Sourcing) Normally Closed	Green	Yellow								
	<b>P</b> <b>K</b>	QD*											
	<b>H</b> <b>Y</b>	5m	NPN (Sinking) Normally Closed	Green	Red								
	<b>H</b> <b>K</b>	QD*											

\*QD = Quick-disconnect      Enclosure classification IEC 529 IP67 (NEMA 6)      CABLES: Robotic grade, oil resistant polyurethane jacket, PVC insulation

**⚠** \*\*WARNING: Do not exceed power rating (Watt = Voltage x Amperage). Permanent damage to sensor will occur.

# SWITCHES

## WIRING DIAGRAMS

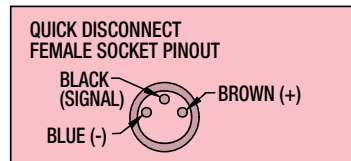
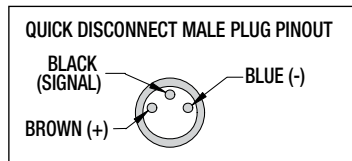
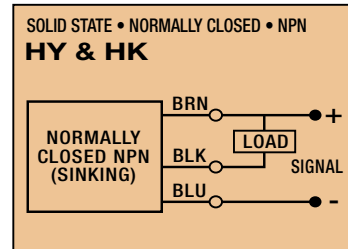
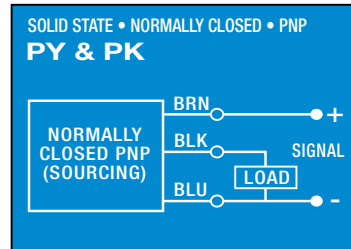
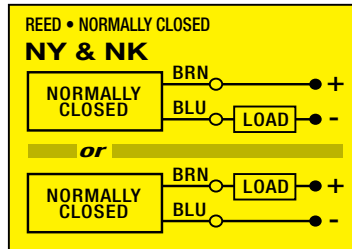
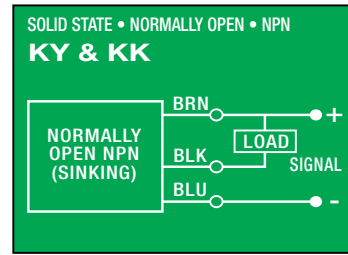
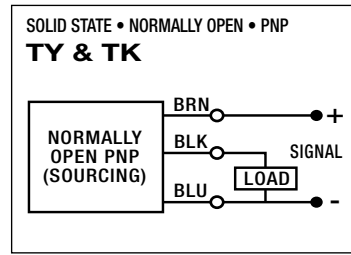
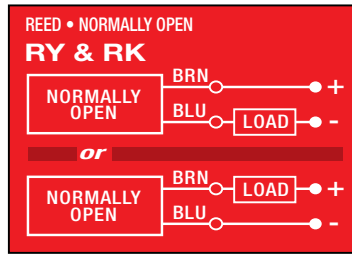

## SWITCH INSTALLATION AND REPLACEMENT

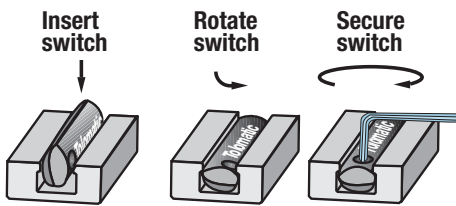

Place switch in side groove on tube at desired location with "Tolomatic" facing outward. While applying light pressure to the switch, rotate the switch halfway into the groove. Maintaining light pressure, rotate the switch in the opposite direction until it is fully inside the groove with "Tolomatic" visible. Re-position the switch to the exact location and lock the switch securely into place by tightening the screw on the switch.

### SWITCH DIMENSIONS

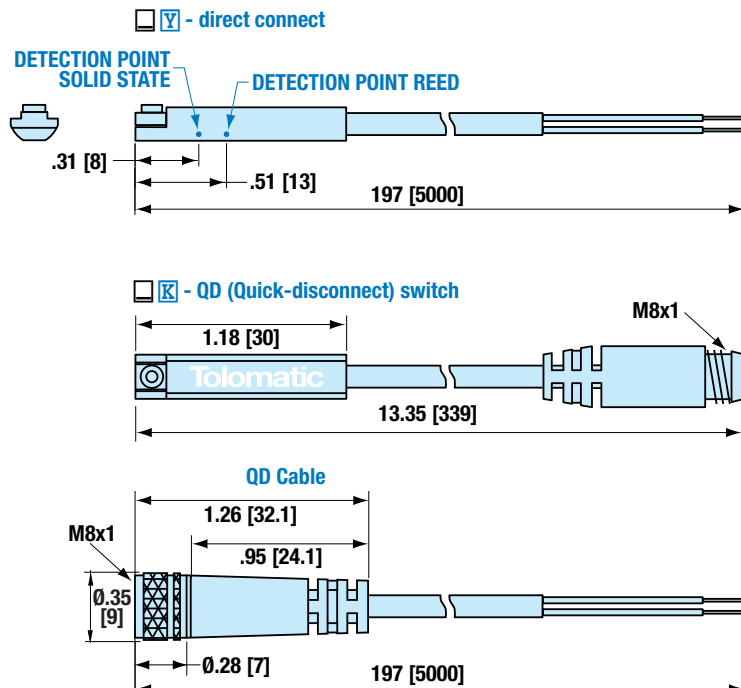

Dimensions in inches [brackets indicate dimensions in millimeters]

### MOUNTING DIMENSIONS

16, 25, 32

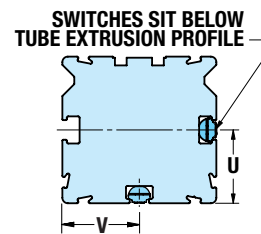

40, 50, 63 SWITCHES SIT BELOW TUBE EXTRUSION PROFILE

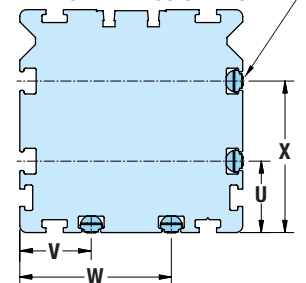

### SWITCH MOUNTING

	MXE16	MXE25	MXE32	MXE40	MXE50	MXE63
<b>U</b>	7.9	20.0	27.0	20.5	27.4	38.0
<b>V</b>	15.0	21.0	27.7	20.5	27.4	38.0
<b>W</b>	-	-	-	43.5	51.4	62.0
<b>X</b>	-	-	-	43.5	51.4	62.0

Dimensions in millimeters

	MXE16	MXE25	MXE32	MXE40	MXE50	MXE63
<b>U</b>	0.31	0.79	1.06	0.81	1.08	1.50
<b>V</b>	0.59	0.83	1.09	0.81	1.08	1.50
<b>W</b>	-	-	-	1.71	2.02	2.44
<b>X</b>	-	-	-	1.71	2.02	2.44

Dimensions in inches

# COMPILE APPLICATION REQUIREMENTS

## APPLICATION DATA WORKSHEET

Fill in known data. Not all information is required for all applications

### ORIENTATION

Horizontal

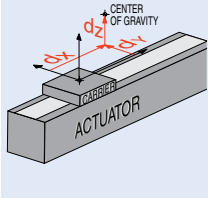

Side

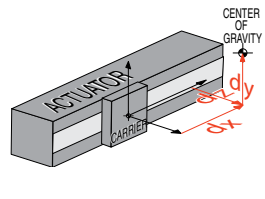

Horizontal Down

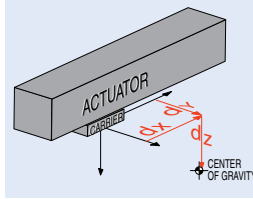

Vertical

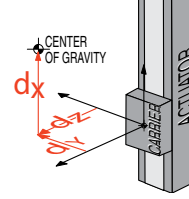

Angled °

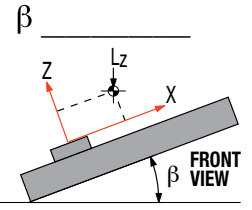
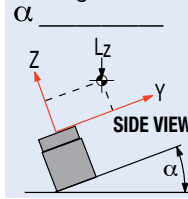

Load attached to carrier OR  Load supported by other mechanism

### DISTANCE FROM CENTER OF CARRIER TO LOAD CENTER OF GRAVITY

$d_x$  \_\_\_\_\_  
 $d_y$  \_\_\_\_\_  
 $d_z$  \_\_\_\_\_

inch (U.S. Standard)

millimeter (Metric)

### STROKE LENGTH \_\_\_\_\_

inch (U.S. Standard)

millimeters (Metric)

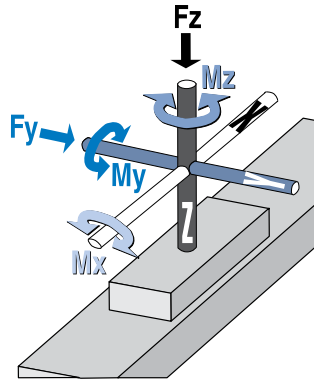

### BENDING MOMENTS APPLIED TO CARRIER

in.-lbs. (U.S. Standard)

N-m (Metric)

$M_x$  \_\_\_\_\_  
 $M_y$  \_\_\_\_\_  
 $M_z$  \_\_\_\_\_

### PRECISION

Repeatability \_\_\_\_\_

inch

millimeters

**NOTE:** If load or force on carrier changes during cycle use the highest numbers for calculations

### THRUST REQUIRED

lbf. (U.S. Standard)

N (Metric)

$F_z$  \_\_\_\_\_  
 $F_y$  \_\_\_\_\_

### OPERATING ENVIRONMENT

Temperature, Contamination, etc.

### LOAD \_\_\_\_\_

lb. (U.S. Standard)

kg. (Metric)

### MOVE PROFILE

Move Distance \_\_\_\_\_

inch

millimeters

Dwell Time After Move \_\_\_\_\_

Max. Speed \_\_\_\_\_

in/sec

mm/sec

### MOVE TIME \_\_\_\_\_

sec

### NO. OF CYCLES \_\_\_\_\_

per minute

per hour

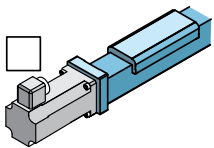

Inline

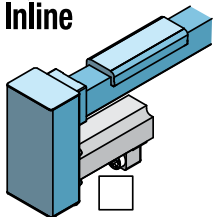

Reverse Parallel

### MOTION PROFILE

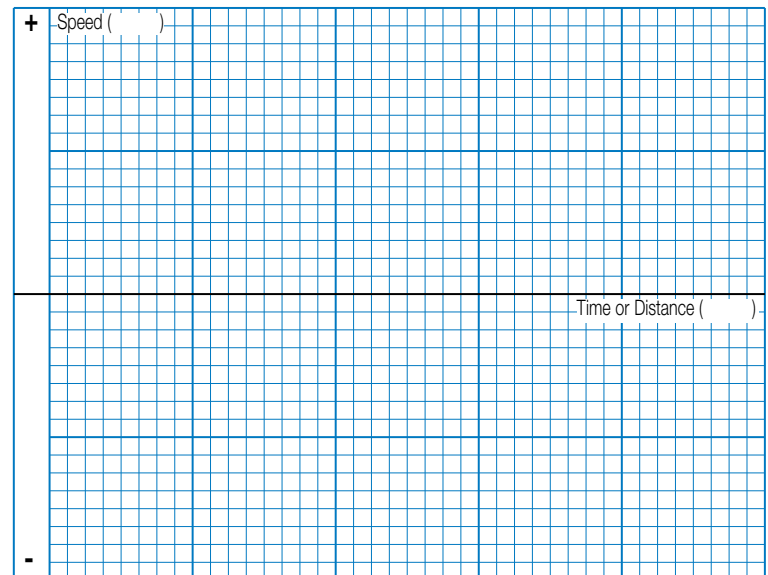

Graph your most demanding cycle, including accel/decel, velocity and dwell times. You may also want to indicate load variations and I/O changes during the cycle. Label axes with proper scale and units.

### CONTACT INFORMATION

Name, Phone, Email  
 Co. Name, Etc.

\_\_\_\_\_  
 \_\_\_\_\_  
 \_\_\_\_\_  
 \_\_\_\_\_



USE THE TOLOMATIC SIZING AND SELECTION SOFTWARE AVAILABLE ONLINE AT [www.tolomatic.com](http://www.tolomatic.com) OR... CALL TOLOMATIC AT 1-800-328-2174.

We will provide any assistance needed to determine the proper actuator for the job.

FAX 1-763-478-8080

EMAIL [help@tolomatic.com](mailto:help@tolomatic.com)

# SELECTION GUIDELINES

The process of selecting a load bearing actuator for a given application can be complex. It is highly recommended that you contact Tolomatic or a Tolomatic Distributor for assistance in selecting the best actuator for your application. The following overview of the selection guidelines are for educational purposes only.

## 1 CHOOSE ACTUATOR BEARING STYLE & SIZE

Choose an actuator that has the thrust, speed and moment load capacity to move the load. Use the Speed/Stroke graph (page MXE\_17) for the screw and the Moment and Load Capacity tables (pg. MXE\_8-11) for the actuator.

## 2 COMPARE LOAD TO MAXIMUM LOAD CAPACITIES

Calculate the application load (combination of load mass and forces applied to the carrier) and application bending moments (sum of all moments  $M_x$ ,  $M_y$ , and  $M_z$  applied to the carrier). Be sure to evaluate the magnitude of dynamic inertia moments. When a rigidly attached load mass is accelerated or decelerated, its inertia induces bending moments on the carrier. Careful attention to how the load is decelerated at the end of the stroke is required for extended actuator performance and application safety. If either load or any of your moments exceed figures indicated in the Moment and Load Capacity tables (pg. MXE\_8-11) for the actuator consider:

- 1) Higher capacity bearing style i.e. **S** Solid to **P** Profiled Rail
- 2) A larger actuator size
- 3) Auxiliary carrier
- 4) External guide system

## 3 CALCULATE LOAD FACTOR LF

For loads with a center of gravity offset from the carrier account for both applied (static) and dynamic loads. The load factor (LF) must not exceed the value of 1.

$$L_f = \frac{M_x}{M_{x_{max}}} + \frac{M_y}{M_{y_{max}}} + \frac{M_z}{M_{z_{max}}} + \frac{F_y}{F_{y_{max}}} + \frac{F_z}{F_{z_{max}}} \leq 1$$

If  $L_f$  does exceed the value of 1, consider the four choices listed in step #2.

## 4 ESTABLISH YOUR MOTION PROFILE AND CALCULATE ACCELERATION RATE

Using the application stroke length and maximum carrier velocity (or time to complete the linear motion), establish the motion profile. Select either triangular (accel-decel) or trapezoidal (accel-constant speed-decel) profile. Now calculate the maximum acceleration and deceleration rates of the move. Acceleration/deceleration should not exceed critical speed (page MXE\_17) for the

### SPEED FACTOR

FOR APPLICATIONS WITH HIGH SPEED OR SIGNIFICANT SHOCK AND VIBRATION: Calculated values of loads and bending moments must be increased by speed factor from the graph below to obtain full rated life of profiled rail bearing system.

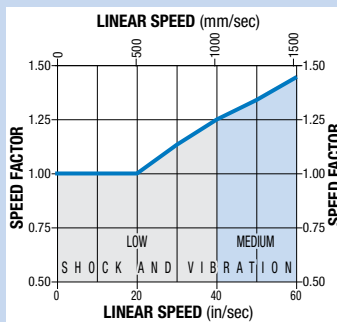

screw/nut combination chosen. Also, do not exceed safe rates of dynamic inertia moments determined in step #3.

## 5 SELECT THE LEAD SCREW

Based on the application requirements for accuracy, backlash, quiet operation, life, etc. select the appropriate lead screw type (Acme screw with a solid nut or ball screw with a standard or anti-backlash nut) and the pitch (lead). For additional information on screw selection, consult "Which Screw? Picking the Right Technology" (#9900-4644) available at [www.tolomatic.com](http://www.tolomatic.com).

## 6 SELECT MOTOR (GEARHEAD IF NECESSARY) AND DRIVE

To help select a motor and drive, use the sizing equations located in the Engineering Resources section of the Tolomatic Electric Products Catalog (#3600-4609) to calculate the application thrust and torque requirements. Refer to Motor sections to determine the motor and drive.

## 7 DETERMINE TUBE CLAMP/MOUNTING PLATE REQUIREMENTS

- Consult the Tube Clamp Requirements graph for the model selected (page MXE\_16)
- Cross reference the application load and maximum distance between supports
- Select the appropriate number of tube clamps, and mounting plates if required for motor and adapter clearance.

# 8 CONSIDER OPTIONS

- Choose metric or inch (US standard) load mounting. (When ordering use **S****K** for inch and **S****M** for metric)
- Switches - Reed, Solid State PNP or NPN, all available normally open or normally closed
- **F****L** Floating mount bracket - used when lack of parallelism occurs between the actuator and an externally guided and supported load (available for **S** Solid bearing style MXE actuators)

### **S** SOLID BEARING 2:1 RULE

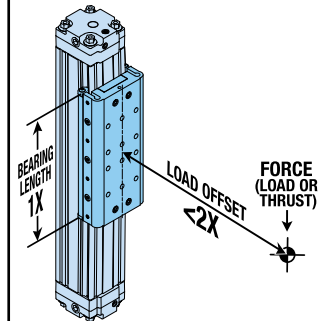

For applications using **S** solid bearings, binding or interrupted motion may occur if the load offset is equal to or greater than twice the bearing length (1X). *LOAD OFFSET* is defined as: the distance from the applied force (or the load center of gravity) to the centerline of the carrier.

If the load offset cannot be changed consider:

- 1.) Higher capacity bearing style, i.e. **S** to **P**
- 2.) Larger Bore Cylinder
- 3.) Auxiliary Carrier
- 4.) Add External Guides

# ADJUSTMENT PROCEDURES

## **S** SOLID BEARING CARRIER ADJUSTMENT

### 16 Series

**NOTE:** MXE16S requires a different carrier adjustment procedure, see below.

Tools Required:

Inch Models: 1/16 inch and 2.5mm Hex Wrench (Key)  
Metric Models: 2 and 2.5 mm Hex Wrench (Key)

1. Loosen endplate screws on both ends of the carrier.
2. Fully loosen all tension and lock screws. They do not need to be removed, just fully loosened.

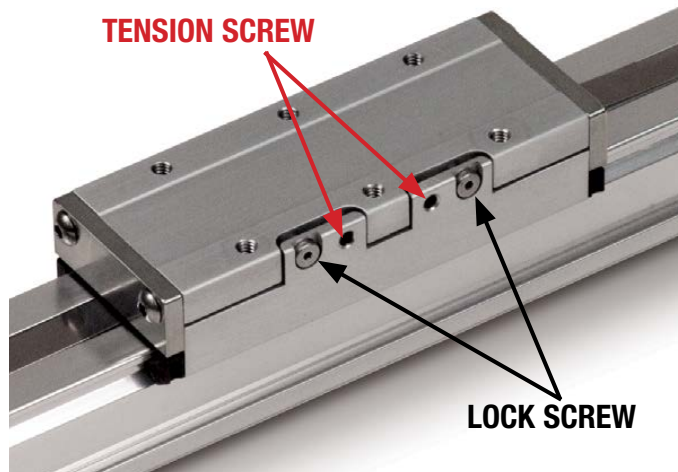

### 25, 32, 40, 50, 63 Series

The **S** solid bearing carrier will provide for maximum life when properly adjusted. The carrier design contains both tension and lock screws. The tension screws control the amount of pressure placed on the carrier bearings. The lock screws lock the tension screws in place and provide fine adjustment of the carrier bearings. The number of tension and lock screws will vary depending on the bore size of the actuator.

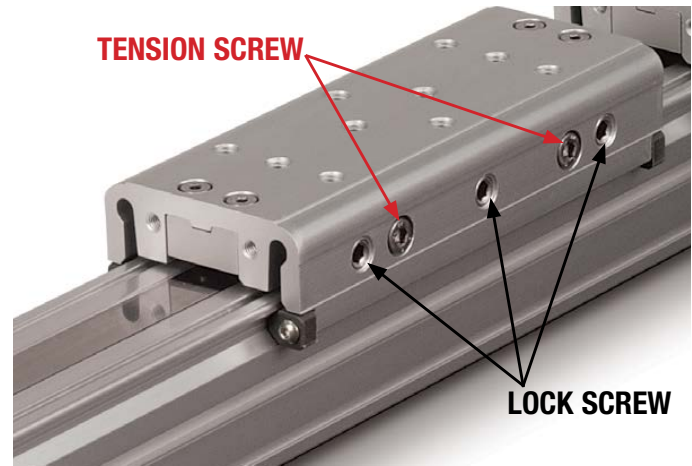

3. Tighten tension screws by turning them clockwise until the carrier is just tight enough so that no side-to-side rocking motion is present and it can easily be moved by hand over the entire stroke length with no hesitation. Very little torque on the screws is required to obtain this condition.

Note: The Tension Screws are the small set screw style fastener. The Lock Screws are the larger, low head, hex drive screws.

4. Tighten lock screws by turning them clockwise until tight. The carrier should feel snug in relation to the tube, with no side-to-side rocking motion present. If the carrier becomes too loose, loosen the lock screws, tighten the tension screws and then retighten the lock screws.
5. Once ideal carrier tension is achieved, fully tighten end plate screws on both ends of the carrier.

1. Fully loosen all tension and lock screws. They do not need to be removed, just fully loosened.
2. Tighten tension screws on both sides of carrier roughly 1/8 to 1/4 turn clockwise past where the screw starts to feel snug. The carrier should be very difficult or impossible to move by hand.
3. Next, adjust the lock screws on both sides of the carrier roughly 1/8 to 1/4 turn clockwise past where the screw starts to engage.
4. Ideal carrier tension is achieved when the carrier feels snug in relation to the tube. No rocking motion should be present. The carrier should be loose enough to be moved by hand over the entire length of the actuator. If after this process the carrier has become too loose, equally adjust all of the lock screws with a slight 1/32 turn counter-clockwise. A carrier that is adjusted too tight will increase the breakaway pressure required for motion; in extreme cases no motion will occur when air is applied.

#### Allen wrench sizes for carrier adjustment, Solid bearing actuators

	Tension Screw		Lock Screw	
	mm	in	mm	in
16	2	1/16	2	1/16
25	4	5/32	3	1/8
32	4	5/32	2	3/32
40	4	5/32	3	1/8
50	4	3/16	2.5	3/32
63	5	1/4	5	3/16

Check out our **MX--S carrier adjustment video on the web**  
<https://youtu.be/LVWPg2gfy0A>

During the application duty cycle, this process may need to be repeated. Keeping the carrier properly adjusted will prolong the life of the **S** solid bearing system.



**sizeit.tolomatic.com** for fast, accurate actuator selection or call Tolomatic (1-800-328-2174) with application information. We will provide any assistance needed to determine the proper MXE screw-driven actuator.



# SERVICE PARTS ORDERING

## REPAIR KITS

Repair kit includes: dust band, end caps, [Also for **S** style: bearings and bearing caps]

The part number for a repair kit begins with RK followed by model, actuator size, bearing type, and stroke length (**SK** = inch/US Standard, **SM** = metric) (NOTE: If unit has an auxiliary carrier also include DC and distance between carrier centers)



## SWITCHES

### TO ORDER SERVICE PARTS SWITCHES:

Switches for MXE include retained mounting hardware and female Quick-disconnect coupler (if applicable). Switches are the same for all actuator sizes and bearing styles

Code	Lead	Normally	Sensor Type
<b>R</b> <b>Y</b>	5m (197 in)	Open	Reed
<b>R</b> <b>K</b>	Quick-disconnect		
<b>N</b> <b>Y</b>	5m (197 in)	Closed	Reed
<b>N</b> <b>K</b>	Quick-disconnect		
<b>T</b> <b>Y</b>	5m (197 in)	Open	Solid State PNP
<b>T</b> <b>K</b>	Quick-disconnect		
<b>K</b> <b>Y</b>	5m (197 in)	Open	Solid State NPN
<b>K</b> <b>K</b>	Quick-disconnect		
<b>P</b> <b>Y</b>	5m (197 in)	Closed	Solid State PNP
<b>P</b> <b>K</b>	Quick-disconnect		
<b>H</b> <b>Y</b>	5m (197 in)	Closed	Solid State NPN
<b>H</b> <b>K</b>	Quick-disconnect		

To order switch kit use configuration code for switch preceded by SW and actuator code.

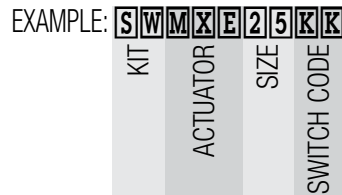

The example is for Solid State NPN, Normally Open Switch with Quick-disconnect couplers. Each switch kit is complete with Bracket, Set Screw, Switch and mating QD cable. Note that the bracket/switch size is common and may be used on any size MXE.

# ORDERING

MODEL SELECTION (MUST BE IN THIS ORDER)

**MXE 40 P SN02 SM2007-02**

OPTIONS (IN ANY ORDER)

**LMI DC215-9 TC8 TK2**

**MODEL**  
MXE MX Rodless Electric Actuator

**SERIES**

16 Series actuator	40 Series actuator
25 Series actuator	50 Series actuator
32 Series actuator	63 Series actuator

**BEARING**

S Solid Bearing  
P Profiled Rail

**NUT/SCREW CONFIGURATION**

SOLID NUT / PITCH (turn/in)	SERIES
SN01	MXE 25, 32, 40
SN02	MXE 16, 25, 32, 40
SN05	MXE 25, 32
SN04	MXE 16
SN16	MXE 16

BALL NUT / PITCH (turn/in)	SERIES
BN01	MXE 63
BNL01	MXE 63
BN02	MXE 40, 50, 63
BNL02	MXE 40, 50, 63
BN04	MXE 63
BNL04	MXE 63
BN05	MXE 40, 50
BNL05	MXE 40, 50
BN08	MXE 25, 32
BNL08	MXE 25, 32
BNM10	MXE 25, 32

**STROKE LENGTH & MOUNTING TYPE**

SK\_ \_ \_ \_ Stroke, enter desired stroke length in **inches**

SM†\_ \_ \_ \_ Stroke, enter desired stroke length in **millimeters**

**NOTE: Actuator mounting threads and mounting fasteners will be either inch or metric; depending on how stroke length is indicated**

**SK=inch mounting**  
**SM= metric mounting**

**MOTOR MOUNTING / REDUCTION**

(must choose one)

**LMI** In-Line mounting  
**LME23** Ext. shaft for RP & 23 frame motor  
**LME34** Ext. shaft for RP & 34 frame motor

**▲ A motor size and code must be selected when specifying a reverse-parallel mounting configuration.**

**RPL1** 1:1 Reverse-Parallel mount left  
**RPR1** 1:1 Reverse-Parallel mount right  
**RPB1** 1:1 Reverse-Parallel mount bottom  
**RPT1** 1:1 Reverse-Parallel mount top  
**RPL2** 2:1 Reverse-Parallel mount left  
**RPR2** 2:1 Reverse-Parallel mount right  
**RPB2** 2:1 Reverse-Parallel mount bottom  
**RPT2** 2:1 Reverse-Parallel mount top

**MOTOR / DRIVE / CONTROLLER / PLANETARY GEARBOX**

**▲ Visit [www.tolomatic.com](http://www.tolomatic.com) for the most up-to-date information or call Tolomatic 1-800-328-2174**

**CARRIER OPTIONS**

**DC** \_ \_ \_ \_ Auxiliary Carrier, enter center-to-center spacing desired in **inches (SK)** or **millimeters (SM)**

(Same unit of measure as stroke length is required)  
**▲ Center-to-center spacing between carriers adds to overall length of the actuator, this distance will not be subtracted from stroke length specified in the previous step**

**BIR** Bracket in Reverse (see page 7 & 30)  
(Carrier) (Mirrored)

**SWITCHES**

**RY**\_ Reed Switch (Normally Open) with 5-meter lead, & enter quantity desired  
**RK**\_ Reed Switch (Normally Open) with 5-meter lead/QD, & quantity  
**NY**\_ Reed Switch (Normally Closed) with 5-meter lead, & quantity  
**NK**\_ Reed Switch (Normally Closed) with 5-meter lead/QD, & quantity  
**TY**\_ Solid State Switch PNP (Normally Open) with 5-meter lead, & quantity  
**TK**\_ Solid State Switch PNP (Normally Open) with 5-meter lead/QD, & quantity  
**KY**\_ Solid State Switch NPN (Normally Open) with 5-meter lead, & quantity  
**KK**\_ Solid State Switch NPN (Normally Open) with 5-meter lead/QD, & quantity  
**PY**\_ Solid State Switch PNP (Normally Closed) with 5-meter lead, & quantity  
**PK**\_ Solid State Switch PNP (Normally Closed) with 5-meter lead/QD, & quantity  
**HY**\_ Solid State Switch NPN (Normally Closed) with 5-meter lead, & quantity  
**HK**\_ Solid State Switch NPN (Normally Closed) with 5-meter lead/QD, & quantity

**FOOD GRADE LUBRICATION**

**LUB**\_ Grease, Food/Drug

**VISIT [www.tolomatic.com](http://www.tolomatic.com) FOR COMPLETE, UP-TO-DATE INFORMATION**

**▲ Not all codes listed are compatible with all options.**

† The metric version provides metric tapped holes for mounting of the load to the carrier and of the actuator to mounting surfaces



[sizeit.tolomatic.com](http://sizeit.tolomatic.com) for fast, accurate actuator selection

**MOUNTING**

**TC**\_ Tube Clamps, enter number of pairs  
**FL** Floating Mount  
**MP**\_ Mounting Plates, & quantity

NOTE: Floating Mount is not available with "P" Profiled Rail



[tolomatic.com/ask](http://tolomatic.com/ask)  
Technical support before and after purchase

[sizeit.tolomatic.com](http://sizeit.tolomatic.com) for fast, accurate actuator selection or call Tolomatic (1-800-328-2174) with application information. We will provide any assistance needed to determine the proper MXE screw-driven actuator.



# The Tolomatic Difference Expect More From the Industry Leader:



## INNOVATIVE PRODUCTS

Solutions with Endurance Technology<sup>SM</sup> for challenging applications.



## FAST DELIVERY

Built-to-order with configurable stroke lengths and flexible mounting options.



## ACTUATOR SIZING

Size and select electric actuators with our online software.



## YOUR MOTOR HERE<sup>®</sup>

Match your motor to compatible mounting plates with Tolomatic actuators.



## CAD LIBRARY

Download 2D or 3D CAD files for Tolomatic products.



## TECHNICAL SUPPORT

Get a question answered or request a virtual design consultation with one of our engineers.

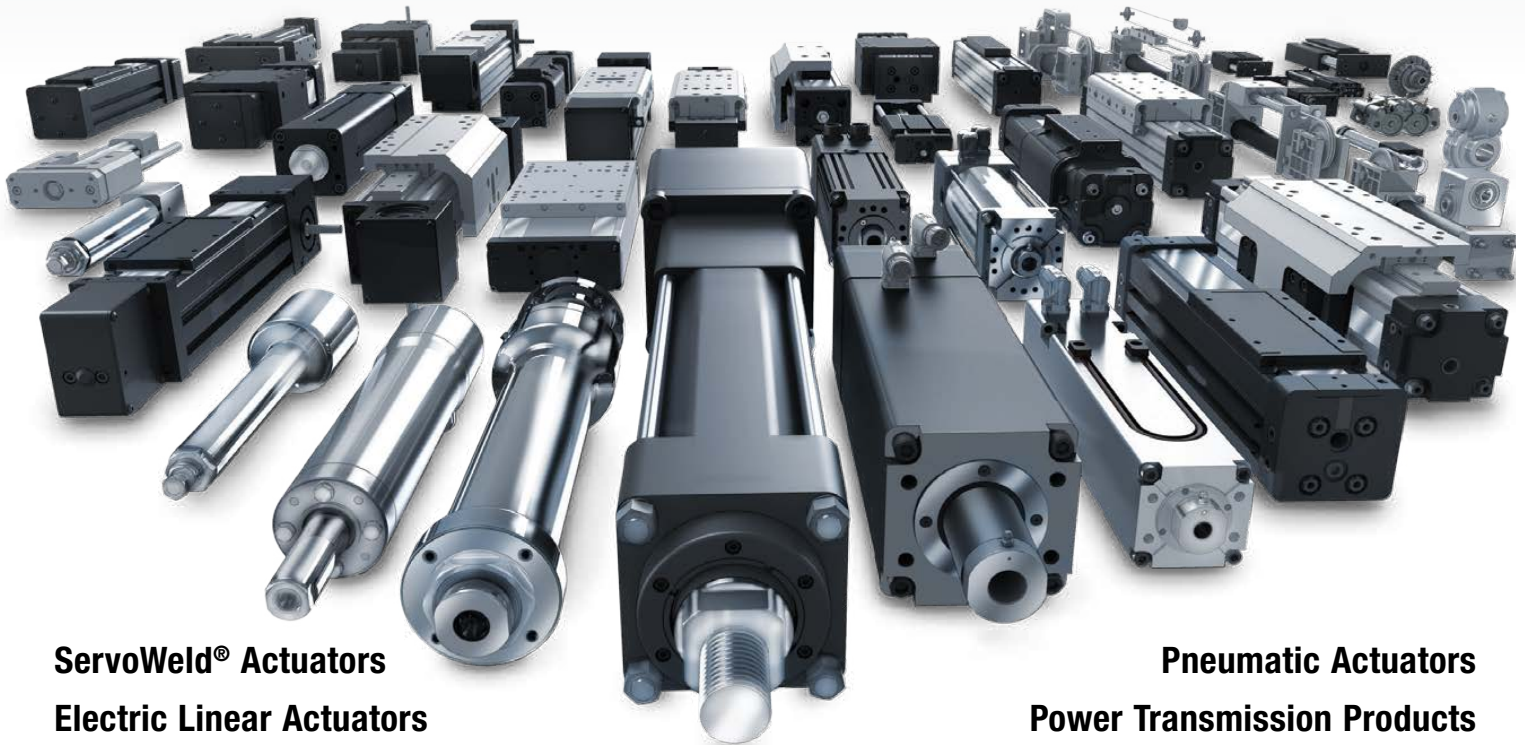

ServoWeld<sup>®</sup> Actuators  
Electric Linear Actuators

Pneumatic Actuators  
Power Transmission Products



MADE IN U.S.A.

# Tolomatic<sup>™</sup>

EXCELLENCE *IN* MOTION

COMPANY WITH  
QUALITY SYSTEM  
CERTIFIED BY DNV  
= ISO 9001 =  
Certified site: Hamel, MN

### USA - Headquarters

#### Tolomatic Inc.

3800 County Road 116  
Hamel, MN 55340, USA

**Phone:** (763) 478-8000

Toll-Free: **1-800-328-2174**

sales@tolomatic.com

[www.tolomatic.com](http://www.tolomatic.com)

### MEXICO

#### Centro de Servicio

Parque Tecnológico Innovación  
Int. 23, Lateral Estatal 431,  
Santiago de Querétaro,

El Marqués, México, C.P. 76246

**Phone:** +1 (763) 478-8000

help@tolomatic.com

### EUROPE

#### Tolomatic Europe GmbH

Elisabethenstr. 20  
65428 Rüsselsheim  
Germany

**Phone:** +49 6142 17604-0

help@tolomatic.eu

[www.tolomatic.com/de-de](http://www.tolomatic.com/de-de)

### CHINA

#### Tolomatic Automation Products (Suzhou) Co. Ltd.

No. 60 Chuangye Street, Building 2  
Huqiu District, SND Suzhou  
Jiangsu 215011 - P.R. China

**Phone:** +86 (512) 6750-8506

Tolomatic\_China@tolomatic.com

All brand and product names are trademarks or registered trademarks of their respective owners. Information in this document is believed accurate at time of printing. However, Tolomatic assumes no responsibility for its use or for any errors

that may appear in this document. Tolomatic reserves the right to change the design or operation of the equipment described herein and any associated motion products without notice. Information in this document is subject to change without notice.

Visit [www.tolomatic.com](http://www.tolomatic.com) for the most up-to-date technical information