

MODEL 30M – INCREMENTAL ENCODER MODULE



Ø30 mm / 1.181"

FEATURES

- Large Air Gap and Tolerance to Misalignment
- Resolutions of 1 to 1024 CPR (4096 PPR with Quadrature Counting)
- Optional 2-Pole to 32-Pole Commutation
- Sealing Options to IP69K
- Operating Temperature Range -40° to 120° C
- Easy Alignment and Installation

The Model 30M is a compact, incremental encoder module with advanced magnetic sensing and signal processing technology. Featuring resolutions from 1 to 1024 CPR, commutation channels, several output types and two supply voltage options, it can be configured for a wide range of industrial, commercial and consumer feedback applications. With a non-contact magnetic sensor and optional sealing up to IP69K, the Model 30M can be applied in environments where dirt, dust and liquids are present.

COMMON APPLICATIONS

- Servo/stepper motor feedback, Mobile equipment speed and steering sensing, Timber processing machinery, Studio lighting and stage equipment control, Rotary valve position monitoring and control, Solar panel positioning, Vending machines, Punch presses, Tank level monitoring, Robotics

MODEL 30M ORDERING GUIDE

Blue type indicates price adder options. Not all configuration combinations may be available. Contact Customer Service for details.

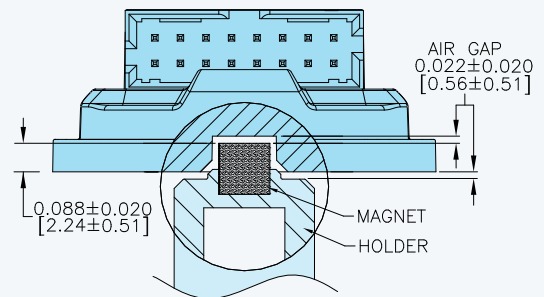
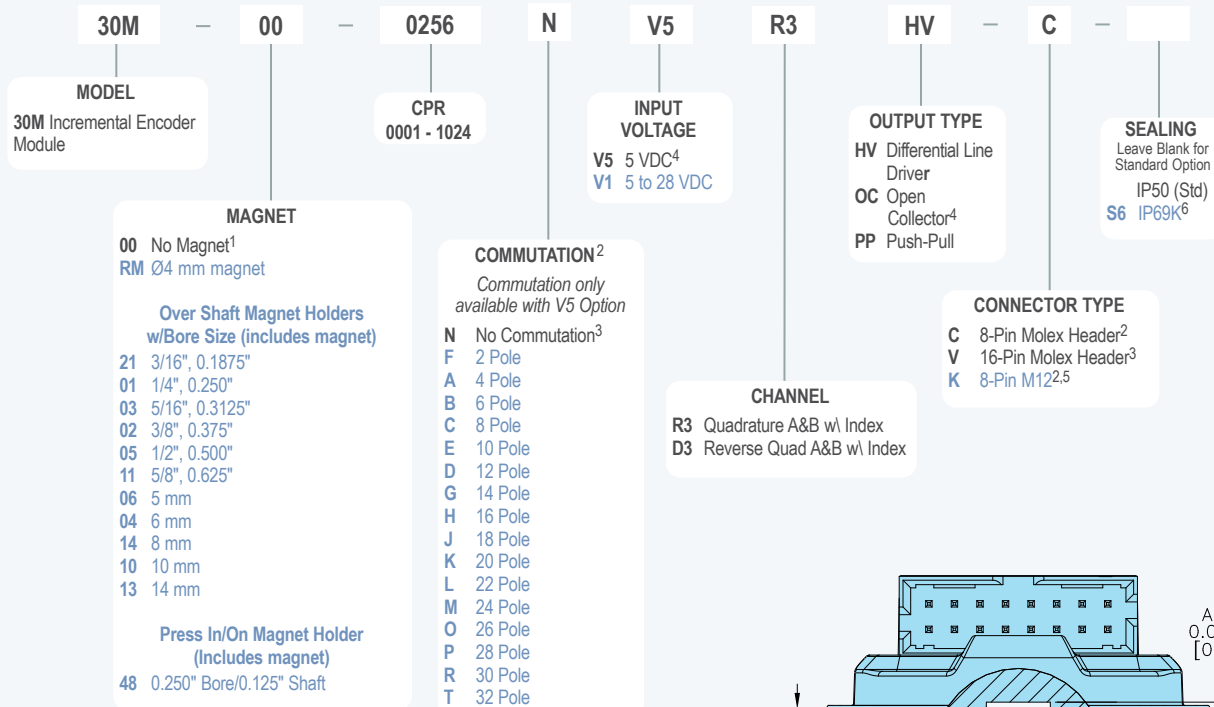

Nominal Magnet Position

NOTES:

- 1 A high-quality magnet is required to generate a reliable signal; magnet options provided by EPC have been pre-qualified to provide a clear and reliable signal.
- 2 Commutation is not available with 8-pin M12 or 8-pin Molex Header.
- 3 16-pin Molex Header is only available with Commutation.
- 4 OC Output Type and 8-pin M12 are not available with V5 Input Voltage option.
- 5 8-pin M12 only available in V1 Input Voltage option.
- 6 IP69K sealing available with 8-Pin M12 Connector Type only.

MODEL 30M SPECIFICATIONS

Electrical

Input Voltage..... 5 VDC \pm 10% Fixed Voltage
4.5 to 28 VDC (4.5 to 20 VDC over 105°C)

Input Current 80 mA max, 50 mA or less typical with no output load

Output Format..... Two square waves in quadrature with channel A leading B for clockwise magnet rotation as viewed from the encoder mounting face. Index gated to A and B.

Output Types..... Open Collector
Open Collector with Differential Outputs
Differential Line Driver (Meets RS422 at 5 VDC)
Push-Pull
All outputs 20 mA max per channel

Max Frequency 350 kHz

Electrical Protection .. Reverse voltage and output short circuit protected. NOTE: Sustained reverse voltage may result in permanent damage.

Min Edge Sep 20° electrical typical @ 25° C

Accuracy..... Typically within \pm 0.7° mechanical from true position. Accuracy improves at nominal air gap with minimized magnet runout, offset and endplay.

Mechanical/Environmental

Operating Temp -40° C to 120° C; reduced to 110° C max above 200 KHz with 20V input and 20mA/channel output

Air Gap 0.022" nominal recommended

User Shaft Tolerances
Axial Endplay..... \pm 0.020" max
Radial Runout 0.008" max
Axial Offset..... 0.008" max

Mounting Bolts Max \varnothing 0.200" Head, 2-56 or M2.5 Button, Socket or Pan Head or 4-40 Socket Head

Housing Material High Temp, Toughened Nylon Composite

Weight..... 0.5 oz typical or less

Humidity..... 98% RH non-condensing

Vibration..... 20 g @ 10 to 2000 Hz (MIL-STD-202G Method 204D)

Shock..... 100 g @ 11 ms duration (MIL-STD-202G Method 213B)

Sealing..... IP50 standard; IP69K available with M12 connector option

8-PIN MOLEX HEADER OPTION (C)

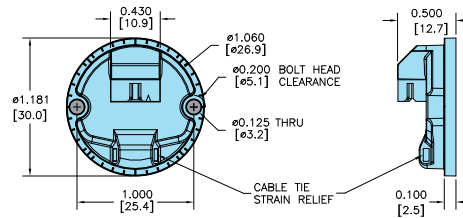

16-PIN MOLEX HEADER OPTION (V)

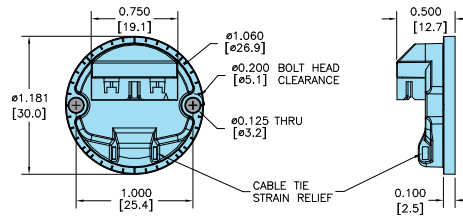

8-PIN M12 OPTION (K)

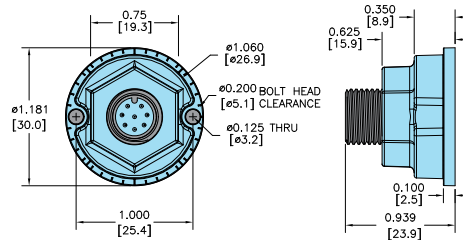

WAVEFORM DIAGRAMS

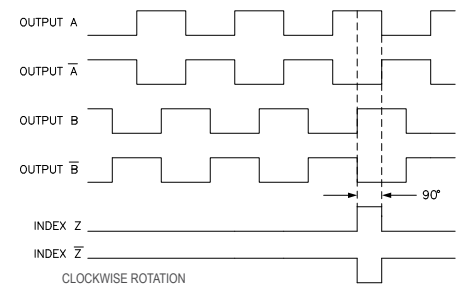

NOTE: ALL DEGREE REFERENCES ARE ELECTRICAL DEGREES. WAVEFORM SHOWN WITH OPTIONAL COMPLEMENTARY SIGNALS \bar{A} , \bar{B} , \bar{Z} FOR HV OUTPUT ONLY.

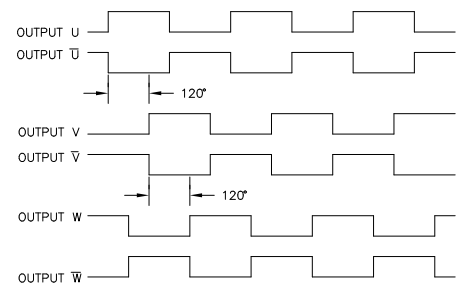

WIRING TABLE

For EPC-supplied mating cables, refer to wiring table provided with cable.
Trim back and insulate unused wires

Function	8-pin M12	8-pin Header	16-pin Header
Com	7	4	8
+VDC	2	2	6
A	1	8	12
A'	3	6	10
B	4	5	9
B'	5	7	11
Z	6	1	5
Z'	8	3	7
U	--	--	2
U'	--	--	1
V	--	--	14
V'	--	--	13
W	--	--	4
W'	--	--	-3

INSTALLATION

Below is the suggested installation for the Model 30M. For additional installation options, please contact EPC Application Support for assistance.

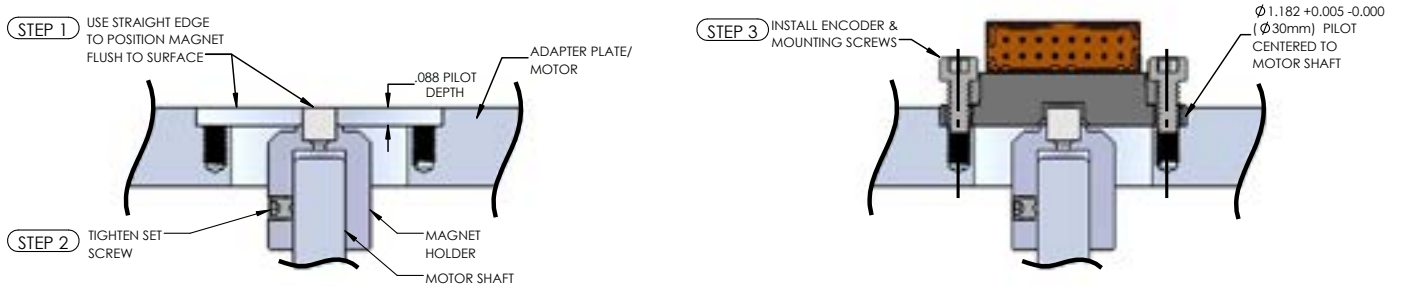

OVER SHAFT MAGNET HOLDERS

STOCK #	ϕ ID	ϕ OD	BL	L
176596-01	3/16" (0.1875")	0.365	0.375	0.580
176597-01	5mm (0.1969")	0.365	0.375	0.580
176598-01	6mm (0.2362")	0.490	0.375	0.580
176599-01	1/4" (0.2500")	0.490	0.375	0.580
176600-01	5/16" (0.3125")	0.490	0.475	0.680
176601-01	8mm (0.3150")	0.490	0.475	0.680
176602-01	3/8" (0.3750")	0.615	0.475	0.680
176603-01	10mm (0.3937")	0.615	0.475	0.680
176604-01	1/2" (0.5000")	0.740	0.750	0.955
176605-01	14mm (0.5512")	0.740	0.750	0.955
176606-01	5/8" (0.6250")	0.865	0.750	0.955

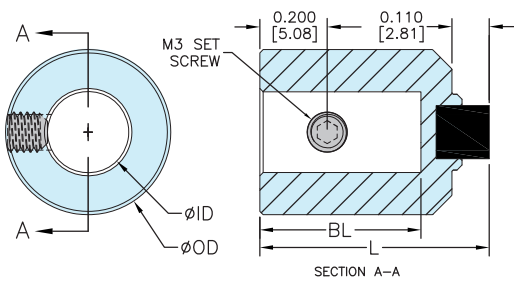

Over Shaft Magnet Holder

PRESS IN/ON MAGNET HOLDER

Stock # 176607-01

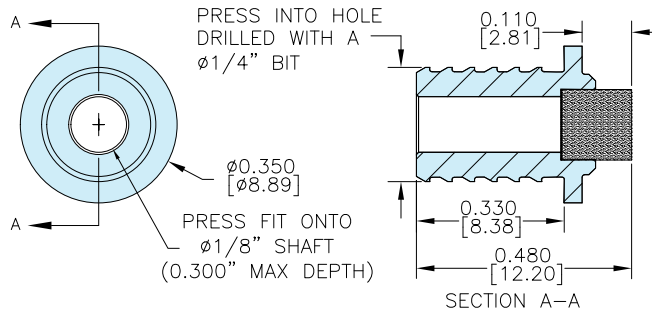

Press In/On Magnet Holder

MATING CABLES/CORDSETS

Molex Mating Cables (24 AWG Wires)	
Stock #	Description
075230	8-pin Molex Mating Connector w/ 24" Cable
075232	16-Pin Molex Mating Connector w/ 24" Cable

M12 Mating Cordsets	
Stock #	Description
075100	8-Pin M12 Mating Cordset, 0.5 Meters
075101	8-Pin M12 Mating Cordset, 2 Meters
075102	8-Pin M12 Mating Cordset, 4 Meters
075103	8-Pin M12 Mating Cordset, 6 Meters
075104	8-Pin M12 Mating Cordset, 10 Meters